

# Wireless Weekly

Vol. 7. No. 1.

NEW IDEAS AT THE EXHIBITION



# A bigger range of Burndept Standard Precision Condensers

—obtainable with Super-Vernier Dials

THE introduction of Burndept Standard Precision Condensers last season met with instant success. Wireless enthusiasts will be pleased to learn that a new type—*Corrected Square Law* pattern—has been added to the range and, further, that these Condensers may be obtained with ordinary dials or with the new Super-Vernier Dial which has attracted so much interest.



Burndept Standard Precision Condenser, fitted with Super-Vernier Dial and with Dust Covers on.

Owing to careful design, the Burndept Condenser absorbs less than 0.05 per cent. of the power applied—a remarkable approach to theoretical perfection. It is ruggedly constructed and the spindle is self-aligning. The upper bearing runs in a flexible steel housing and the lower bearing consists of a metal cone running in gun-metal. Contact is perfect, and the movement is very smooth. These Condensers are absolutely noiseless even when used on waves as low as 40 metres. To protect the plates from dust and to obviate hand capacity effects, metal snap-on covers are provided.

The description, "*Corrected Square Law*," needs a little explanation. Most square law condensers are designed without regard to initial circuit capacity, but the plates of the Burndept Corrected Square Law Condenser are of special shape giving wave changes truly proportionate to dial settings.

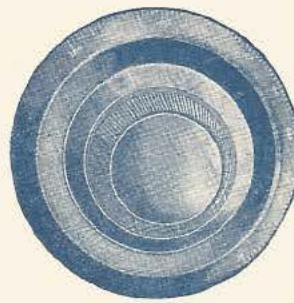

The Burndept Super-Vernier Dial looks like an ordinary dial, but the concealed mechanism enables critical adjustments to be made quite easily.

STANDARD CONDENSERS. All Metal, completely enclosed type.

Model S. V. Fitted with Super-Vernier Dial and Knob.

No. 917.	Corrected Square Law, .00027 mfd.	£1 7 6
No. 918.	Corrected Square Law, .0005 mfd.	1 12 6
No. 919.	Normal Type, .0005 mfd.	1 7 6
No. 920.	Normal Type, .001 mfd.	1 15 0

Model N. Fitted with Black Bakelite Dial and Knob.

No. 921.	Corrected Square Law, .00027 mfd.	£1 2 6
No. 922.	Corrected Square Law, .0005 mfd.	1 7 6
No. 923.	Normal Type, .0005 mfd.	1 2 6
No. 924.	Normal Type, .001 mfd.	1 10 0

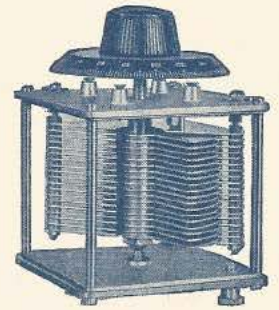

Burndept Standard Precision Condenser fitted with ordinary dial, and with Dust Covers removed.

The new Burndept Super-Vernier Dial is ideal for controlling vario-couplers, etc., as well as condensers and enables fine adjustments to be made with ease. It is no larger than an ordinary dial and can be fitted to almost any set without dismantling the instrument. The reduction of about 7:1 is effected by means of a novel friction-driven epicyclic gear, which is perfectly smooth and silent in operation. The gear ratio of 7:1 has been selected after careful trial as the most suitable. There is nothing whatever to go wrong and slight wear is self-compensated. Dials have required no adjustment after an experimental run of half a million revolutions.

No. 905.	Model A. For $\frac{1}{2}$ " spindles (no projections above panel) complete with knob, etc.	7/6
No. 907.	Model B. For $\frac{1}{4}$ " and $\frac{1}{2}$ " spindles (one-hole fixing condensers, etc.) complete with knob, distance ring, etc.	8/6

Write for a copy of our latest 100-page catalogue, sent free on request.

## BURNDEPT

### WIRELESS LIMITED

Head Office: Aldine House,  
Bedford Street, Strand,  
London, W.C.2  
Telephone: Gerrard 9072.  
Telegrams: Burndept,  
Westrand, London.

Branches at Birmingham,  
Brighton, Bristol, Cardiff,  
Exeter, Glasgow, Leeds,  
Liverpool, Manchester, New-  
castle, Northampton and  
Nottingham.

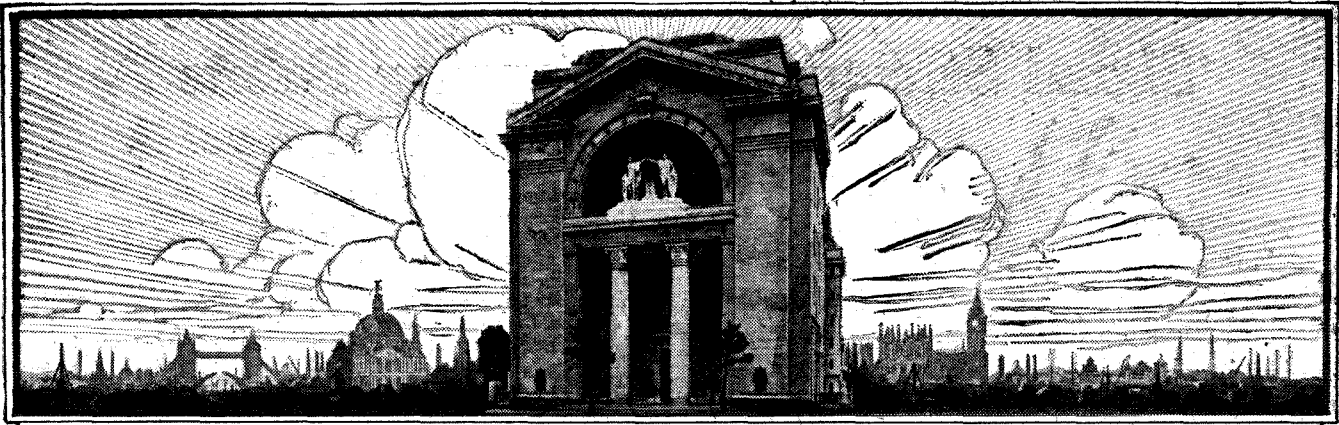

Radio Press LTD

Wireless Weekly

Phone City, 9911

Bush House STRAND-WGZ

## The B.B.C. and their Wavelength Standards

ON another page we publish some interesting and highly important figures relating to the wavelengths of the British Broadcasting Company's stations. Technically the figures speak for themselves, but there are other aspects of the case which we think are of equally vital importance.

The British Broadcasting Company, in our opinion, should set the highest possible standard in all matters with which it deals. We, in this country, are justly proud of our broadcasting service, and its praises have been sung by visitors from all parts of the world. Thousands of sets have been designed for no other purpose than to listen to the concerts from these stations, and a vast amount of experimental work is continually in progress. Should we not assume that when the British Broadcasting Company publishes the wavelengths of its stations reasonable accuracy may be expected? A slight and occasional variation from the published figures would be understandable, as accidents happen in the best regulated stations, but for some time we have been seriously concerned with the consistent divergence from the published figures of more than one of these transmissions. The most glaring case is, of course, that of London. Here the published wavelength is 365 metres (821.4 kc.), whereas our own

laboratory measurements show the figure to be 357.7 (838.19 kc.). For months past the wavelength of the London station has been nearer 360 than 365 metres.

For a considerable time manufacturers of wavemeters have been worried by complaints from their

manufacturer, he will naturally take the word of the B.B.C.

Again, on the question of selectivity, there are still more worrying problems. London, according to the published wavelengths, falls at a certain definite distance between Manchester and Cardiff. For a long time it has been almost impossible in certain areas to separate the Cardiff station from London, although the difference in wavelength according to the published figures should enable such a separation to be effected. An examination of the figures published in Dr. Robinson's article will show that the kilocycle difference between the two stations is so small as to make selectivity, with any other instrument than a super-heterodyne, a most difficult task.

If the B.B.C. change their actual wavelengths to "dodge" interference from foreign stations, these latter are themselves in a quandary. By making such changes a position arises similar to that when two people meet and each tries to dodge the other. Collision is, in most cases, inevitable. It is worth noting that in the United States, where the congestion of stations is one of the biggest problems to be solved, such fluctuations in wavelength are never permitted, and a station which consistently broadcast on a wavelength different from that allotted to it, would have its licence suspended.

CONTENTS.	
	Page
Signal Strength and Tapping Points	2
Some New Loud-speakers at the Exhibition	4
Long or Short Waves?	6
Some New Designs of Variable Condensers	9
Why Dull Emitter Valves are Silvered	11
Jottings by the Way	12
When to use a Low-loss Coil	14
The Problems of Absorption and Fading	16
Wireless News in Brief	19
The B.B.C. and their Published Wavelengths	20
Thirty Years of Wireless—A Survey	22
Inventions and Developments	24
Apparatus We Have Tested	26
Correspondence	28
Information Department	31

customers that the instruments are wrong. In most cases it has been impossible to persuade the customers that the B.B.C. wavelengths are not correctly given. This attitude on the part of the customer is easily understood, for when he is asked to choose between the British Broadcasting Company's official figures and the statements of a

Director of Research:  
Major JAMES ROBINSON, D.Sc., Ph.D.,  
F.Inst.P.  
Assistant Editor:  
PERCY W. HARRIS, M.I.R.E.  
Scientific Adviser:  
Prof. G. W. O. HOWE, D.Sc., M.I.E.E.  
Advisory Editors:  
Prof. R. WHIDDINGTON, M.A., D.Sc., F.R.S.  
Prof. C. L. FORTESCUE, M.A. M.I.E.E.

Edited by  
**JOHN SCOTT-TAGGART,**  
F. Inst. P., A.M.I.E.E.

September 23, Vol. 7, No. 1.

Staff Editors:  
E. H. CHAPMAN, M.A., D.Sc.  
A. D. COWPER, M.Sc.  
R. W. HALLOWS, M.A.  
G. P. KENDALL, B.Sc.  
A. JOHNSON-RANDALL  
STANLEY G. RATTEE, M.I.R.E.  
J. H. REYNER, B.Sc. (Hons.),  
A.C.G.I., D.I.C.

# Signal Strength and Tapping Points

By A. D. COWPER, M.Sc., Staff Editor.

*The growing vogue of untuned aerial circuit arrangements raises several questions relating to the design of the primary winding. The results given here of some preliminary experiments made by Mr. Cowper should prove extremely suggestive. Further tests upon the effect of coupling variations are suggested to those readers possessing the necessary simple equipment.*

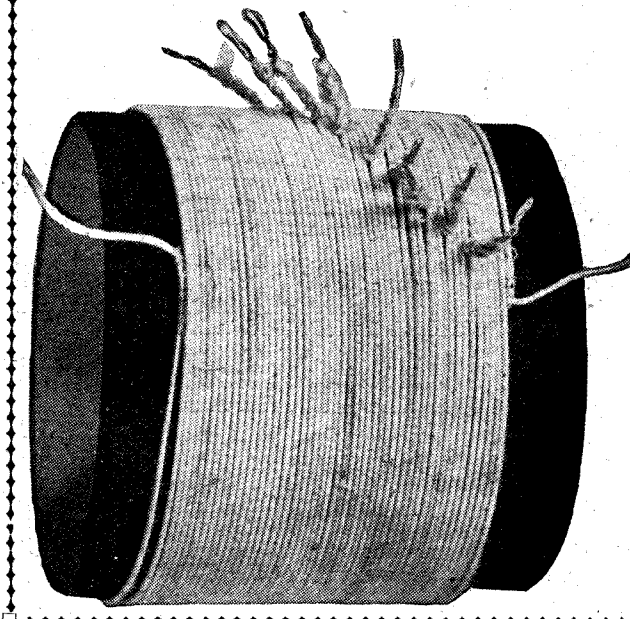

IN a number of modern types of selective circuits a tapping point is taken from an aerial or secondary inductance for the purposes of rough tuning, giving what is called (for lack of a better name) a "semi-aperiodic" system. Tuning is thus greatly simplified, in many cases the number of tuning points being reduced whilst still permitting of fine, selective tuning at some other point in the circuit.

Without careful design, however, serious loss of signal-strength may result from this compromise. It seemed of interest, therefore, actually to measure the signal-strength in a low-loss secondary circuit with various "semi-aperiodic" couplings, at various different tapping points, in comparison with conventional tuned coupling arrangements and with the optimum value obtainable by any means available.

### Method of Measurement

Measurements were made by the familiar Moullin voltmeter method upon the local station's wave and on a large high aerial of fairly low resistance in conjunction with a good earth. A previously calibrated R valve was used, with 48 volts H.T. and 4 megohms grid-leak; under these circumstances the scale is fairly linear up to 3 volts signal-voltage. In any case, relative rather than absolute values are required, and the observed signal-strength is recorded in virtual "volts."

The usual precaution was taken to provide a low-resistance H.F. path from the anode to the filament circuit by blocking condensers across 'phones and milliammeter. The transmission varied slightly in strength during the measurements; comparison was made in each case with the current value on a standard coupling.

### Effect of Primary Tappings

Fig. 1 shows the observed change of signal-strength in the secondary with different primary turns, when using a separate tapped primary fairly loosely coupled

at 2 in. below the filament end of the low-loss grid inductance. This corresponds roughly to the conventional Reinartz type of circuit, with semi-aperiodic tapped primary, though rather more loosely coupled than with some versions of that circuit. A marked optimum tapping point is noticeable, and the shape of the curve suggests that quite fine tapping of the primary would be advisable for *critical* work. The 30 turns of No. 22 d.c.c. on a 3-in. former were found, on separate test with a crystal rectifier (to avoid introducing extra stray capacities), to tune the large aerial to the frequency of reception, about 821 Kc. (about 364 metres).

### Comparison with Auto-coupling

A marked improvement over direct series-condenser coupling of the same low-loss (secondary) inductance to the aerial was shown in this case, even with very roughly adjusted primary tappings. The practical optimum was reached with auto-transformer (aerial tap) coupling at the 11th turn on the grid inductance. This was of the same order as the optimum with separate primary of 30 turns.

### Effect of Filament Tapping

Fig. 2 shows the effect of connecting the filament circuit to a tapping point part of the way up the grid

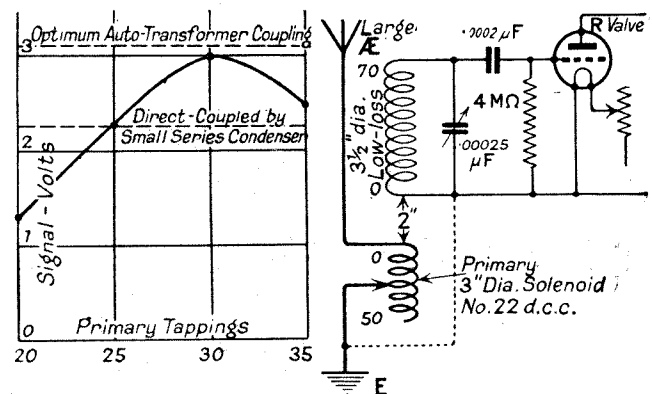

Fig. 1.—When the coupling between primary and secondary is fairly loose the author finds that a definite optimum value exists for the primary turns for a given wavelength.

inductance, thus including a smaller number of turns across grid and filament, and naturally diminishing the proportion of the total H.F. voltage across the tuning-inductance applied to the grid. When this tapping point is made halfway up, we obtain an arrangement recalling the familiar Hartley transmitter circuit, but omitting the anode connection of that circuit.

**Unexpected Results**

Rather surprisingly it is found that the available grid signal-voltage is *not* greatly diminished by this device, even when the tapping point is made one quarter of the way up the inductance; a mean of

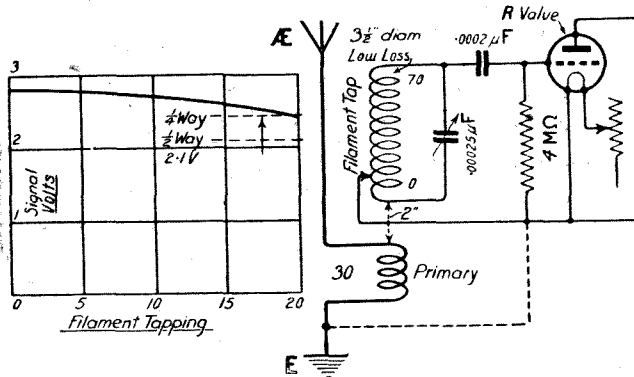

Fig. 2.—The use of a filament tap produced a surprisingly small reduction in signal strength.

around 90 per cent. of the maximum available signal-voltage was registered with a one-quarter filament tap, and even with a centre (Hartley-type) tap the actual voltage registered was 75 per cent. of the maximum. The diminished grid-damping had evidently compensated to some extent for the voltage-partition. Since in some types of capacity reaction circuits a filament tap is taken thus at a point part way up the grid tuning inductance, it is of considerable interest and importance to note that very little signal-strength is lost in this manner. A constant optimum primary coupling of 30 turns on a 3-in. solenoid of No. 22 d.c.c. at 2 in. below the filament-tap-end was used in this series of measurements.

**Aerial Tapping Points with Filament Tap**

Trying now the effect of different aerial tapping points in conjunction with a 1/4 filament tap circuit, with the aerial tapping point outside the filament tap (Fig. 3), it was found that there was very little change as the tapping point was moved inward, until the point was reached at which 11 turns were included in the aerial circuit—the number previously found as optimum for plain auto-transformer coupling. Below this the signal-strength fell off rapidly, as might be expected. The maximum number of turns available, 17 in this

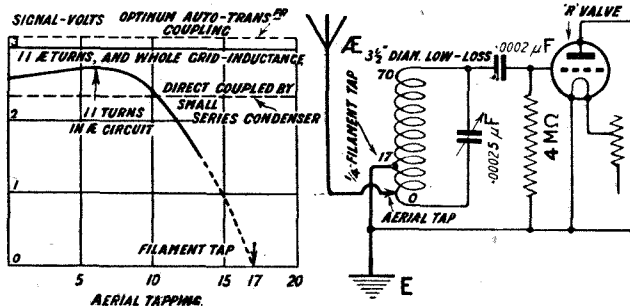

Fig. 3.—Showing the relation between signal strength and aerial turns when a filament tap is also employed.

case, did not suffice at all to tune the aerial to the frequency of reception.

**Fine Aerial Tapping Suggested**

It was noted that the selectivity increased with a smaller number of aerial turns in use, as should

obviously be the case. The optimum value of signal strength reached with this arrangement was in one series 87 per cent., and in a second series 91 per cent. of the practical optimum attained with auto-transformer coupling and full grid inductance in use. A fairly fine tapping for the aerial connection is evidently desirable in this type of circuit, but with this provision the signal-strength can be very satisfactory.

**Closer Coupling**

The last arrangement investigated (Fig. 4) was that of a close-coupled small primary of rather "high-loss" design inserted actually inside the secondary, after the manner of some American receivers. In this case the secondary was the same 3 1/2 in. diameter low-loss coil of 70 turns of air-spaced large gauge enamelled wire used in the other experiments, and the primary was placed close to but actually just beyond the end of the secondary winding. This corresponds closely to the case of a fixed tapped primary wound on the same former beyond the secondary, with e.g., a 1/4 in. gap between, or to the original Reinartz arrangement.

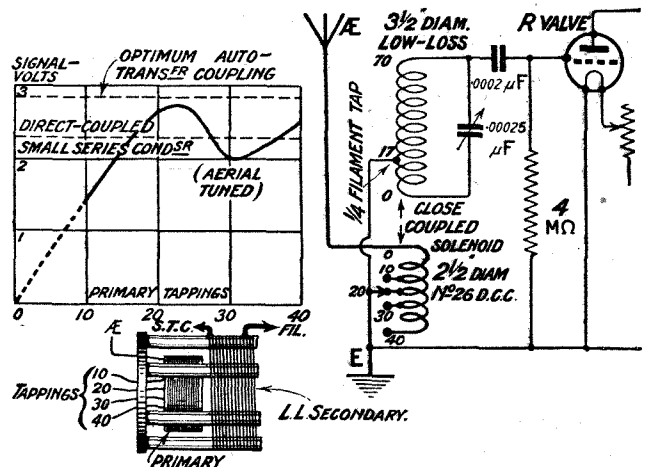

Fig. 4.—When the primary and secondary coupling is tight a peculiar shaped curve results.

The one-quarter filament tap was used, as before, and the primary was a small solenoid of 40 turns of No. 26 d.c.c. wire closely wound on a 2 1/2 in. diameter cardboard former and tapped at turns Nos. 10, 20 and 30. Separate tests showed that this tuned the large aerial very closely to the frequency of reception with 30 turns. The effect of this close tuning and close coupling is shown in a marked manner by the curve; a rapid increase when 20 turns of primary inductance are used, compared with the poor showing with but 10 turns, and then a decrease with 30 turns, followed by an increase to almost the optimum figure with 40 turns.

**Advantages of Detuned Aerial Circuit**

The effect on reaction requirements in a reaction circuit of this phenomenon is quite prodigious, and the curve should emphasise a point which the writer has frequently dwelt upon in connection with such circuits with semi-aperiodic couplings, namely, that the aerial circuit should be kept a little *detuned* above the frequency of reception for best results.

The signal-strength is again excellent, being some 95 per cent. of the optimum with most favourable auto-transformer coupling, compared with 65 to 74 per cent. observed on my aerial with direct series-condenser coupling.

# Some New Loud-Speakers at the Exhibition

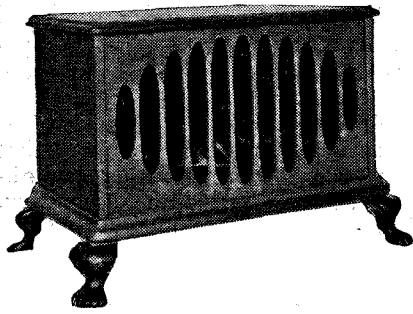

The C.A.V. hornless loud-speaker.

*Each year the Exhibition provides something in the nature of a summary of progress in loud-speaker development during the previous twelve months. A special description appears on these pages of some of the latest instruments seen at the Albert Hall by a representative of "Wireless Weekly"*

A feature that has been adopted fairly generally is the wood or semi-wood horn, and there also is a certain tendency towards the use of non-resonant materials for the construction of loud-speaker horns. The external finish would appear to be slightly better than that shown last year, and sound boxes are a little heavier in some cases.

### Research Work

Many manufacturers have spent considerable money in experiment and research on loud-speakers, but most of them confess that they have been little able to improve on their last year's models, such improvements as have been effected being in regard to smaller details of construction.

### Ornamental Types

There is a definite movement in the direction of making the loud-speaker an ornament, and one or two models of pedestal loud-speaker are to be seen, which provide a very effective disguise. Other loud-speakers of conventional design are obtainable in various styles of finish so as to match with different types of furniture. Cabinet instruments are also available in different makes.

### The Radiolux Amplion

Two rather decided new departures are the Radiolux Amplion and the Polar Audalio speakers. The first of these is built to resemble the English bracket clock. It incorporates several distinctive features in its construction. The electromagnetic unit has a threaded nozzle, by means of which it is screwed into the tone arm or duct. This duct curves into a reflecting bowl of special contour, the two being supported on a perforated steel-ribbed plate. The whole is mounted in the wooden casing by means of rubber washers, so as to insulate it from the cabinet. The steel base plate is perforated so as to afford free circulation round the radiating or reflector bowl, and so avoid the possibility of unwanted resonance due to the vibration of an im-

prisoned air column. The two terminals are of the spring type, to take either pin or spade tags, and similar terminals are fitted to all the new Amplion models.

### The New Polar Instrument

The Polar Audalio is also quite distinctive in appearance. A light wooden frame with end pieces has within it a coloured silk screen. Within this, but not visible, is a cylinder of specially prepared material to which wires are attached. These wires are fixed at their other ends to the armature of the electromagnetic system by means of which the vibrations are transferred to this cylinder. It is claimed that since no horn is used radiation of sound is attained without introducing "horn" distortion, and that it takes place all round, that there are no metal parts to cause "tinniness," and that it has no noticeable resonance over the whole frequency range up to 15,000 vibrations

**I**F a careful survey of the loud-speakers exhibited at the Albert Hall is made to see what improvements in design and construction have been effected in the past year, the result in the aggregate is rather disappointing. In very many cases models will be found to

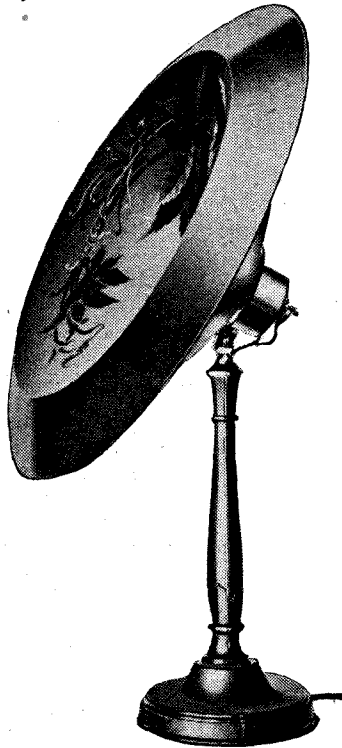

The "Mellovox" loud-speaker, introduced by Messrs. Sterling, operates upon a similar principle to that employed in their larger model (the "Primax").

be practically the same as last year, and, with the exception of one or two cases, any improvements made are merely in the details, and not in the fundamentals of construction and design.

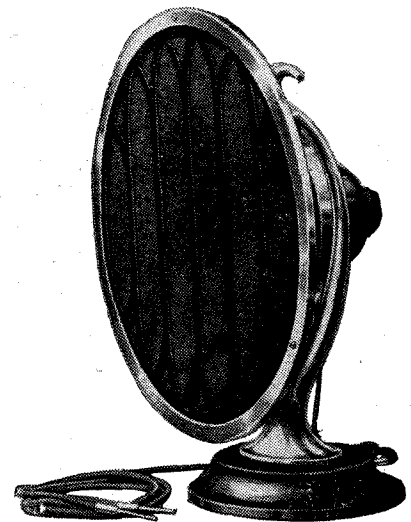

The B.T.H. type E loud-speaker is a hornless instrument.

a second. We understand that the armature is of the reed type, and that the magnets are adjustable.

What is claimed to be an important improvement in the C2 model B.T.H. loud-speaker is the

use of a moulded instead of a metal base. The magnet assembly is moulded into a composition housing which screws into the base proper. This has been done with

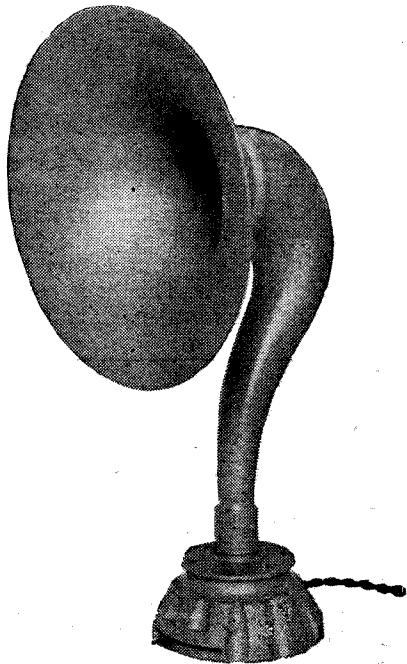

The new Ericsson loud-speaker incorporates an improved magnet assembly.

the object of eliminating any ring due to the presence of unnecessary metal, and further to conduce to this the diaphragm is clamped between cork washers. The magnets are, of course, adjustable.

**A Hornless B.T.H. Model**

Then there is the new B.T.H. model E hornless loud-speaker, in which the diaphragm is not supported at the periphery, so as to give freedom from unwanted resonance. Another feature is their

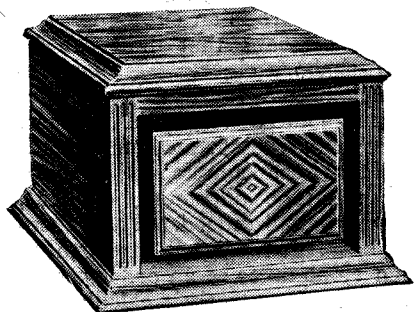

The Brown cabinet loud-speaker.

loud-speaker which is disguised as a table lamp, and which may be used as such.

**New G.E.C. Diaphragms**

A feature of the General Electric Co. loud-speakers is the fact that

all their diaphragms are nickel-plated. This has been done as it was found that the enamel on stalloy diaphragms was liable to chip, and that, being magnetic, it fell between the pole pieces of the magnets, where it was liable to set up annoying chatter.

**An Improved Assembly**

Messrs. the British Ericsson Manufacturing Co. state that their new magnet assembly allows the magnets to be adjusted without any risk of the whole unit vibrating, and thus setting up unpleasant effects.

**C.A.V. Developments**

In order to prevent cushioning effects Messrs. C. A. Vandervell have drilled a hole through their loud-speaker diaphragms, while a recent patent of this firm covers the method of cutting slots in diaphragms and filling these slots with lead or some such metal to prevent resonance effects.

Messrs. C. A. Vandervell also produce a cabinet loud-speaker, which has a pleasing appearance, and should harmonise with most receivers.

**New Brown Instruments**

In the new "Q" type loud-speaker made by Messrs. S. G. Brown a new diaphragm is fitted, which is doubled back on itself and clamped on the inside, the other side of it being clamped to the reed at the centre; it thus has a free edge as well as a larger surface.

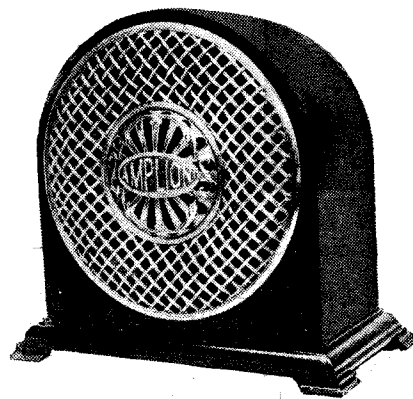

The compact new Amplion has been named "Radiolux."

This arrangement is claimed to be a great improvement. In their new cabinet type a new shape of horn is used, which, although unconventional in theory, in actual practice, we understand, is most successful. Their new power loud-speaker employs two diaphragms in opposition. Two reeds are used with aluminium diaphragms which have been made as light as possible.

**SHORT-WAVE CALIBRATION SIGNALS**

For the benefit of those of our readers who are experimenting upon the very short waves, and who wish to have some means of calibrating their sets, we give a further list of the principal stations working upon wavelengths from 20 metres upwards to 90 metres. These stations are located in different countries, as indicated below; the majority are received quite strongly in this country on a single valve receiver. In the first column we give the wavelengths, while in the second will be found the frequency in kilocycles per second, followed by the call signs and location of each station.

Wave-length in metres.	Frequency in kc.	Call Sign.	Location.
20.0	14,991	POX	Nauen, Germany.
25.0	11,992.8	2YT	Poldhu, England
25.0	11,992.8	POY	Nauen, Germany
26.0	11,531.5	POX	Nauen, Germany
30.0	9,994	2XI	Schenectady, N.Y.
32.0	9,369.4	2YT	Poldhu, England
35.0	8,566.3	2XI	Schenectady, N.Y.
36.0	8,328.3	LPZ	Buenos Aires, Argentina
38.0	7,837.3	2XI	Schenectady, N.Y.
40.0	7,496	1XAO	Belfast, Me.
43.0	6,972.5	WIR	New Brunswick, N.J.
47.0	6,379.1	POZ	Nauen, Germany
50.0	5,996	NKF	Anacostia, D.C.
56.0	5,353.9	KFKX	Hastings, Nebraska
58.79	5,099.8	KDKA	East Pittsburgh, Penna.
60.0	4,997	1XAO	Belfast, Me.
60.0	4,997	2YT	Poldhu, England
62.0	4,835.8	KDKA	East Pittsburgh, Penna.
67.0	4,474.9	8XS	East Pittsburgh, Penna.
70.0	4,283	POX	Nauen, Germany
71.5	4,193.2	NKF	Anacostia, D.C.
74.0	4,051.5	WIR	New Brunswick, N.J.
75.0	3,997.6	SFR	Paris, France
75.0	3,997.6	WGN	Rocky Point, L.I.
76.0	3,945.0	POX	Nauen, Germany
83.0	3,612.3	RDW	Moscow, Russia
84.0	3,569.3	NKF	Anacostia, D.C.
85.0	3,527.3	SFR	Paris, France
85.0	3,527.3	8GB	Paris, France
86.0	3,486.2	NQC	San Diego, California
90.0	3,331	6XO	Kahuku, T.H.
90.0	3,331	1XAO	Belfast, Me.

# LONG OR SHORT WAVES?

By MAJOR JAMES ROBINSON, D.Sc., Ph.D., F.Inst.P., Director of Research to Radio Press, Ltd.

In this article (the second of his special series) Dr. Robinson discusses some extremely interesting problems of wave propagation, and considers some of the factors governing the choice of wavelength for long distance communication.

**T**HE brief description of some of the characteristics of high-power long-wave stations in last week's issue will suffice to show that the design of such stations is a highly technical problem, and no doubt exists that these stations have become excellent engineering propositions which can guarantee good service. They are operating at the present day, and there is no doubt that they will continue to operate for many years to come in the general form in which they exist at present. An excellent feature of this type of station is that good service can be guaranteed. A daily service of nearly 24 hours can be guaranteed over distances of 2,000 to 3,000 miles, and, in fact, if very high power is used, this complete daily service can almost be guaranteed over ranges up to 8,000 miles. The famous case of the Malabar station in Java can be referred to where 19 hours' daily service to Holland is

speed of signalling is increased the time allowed for a dot gets smaller. Long waves require also an appreciable amount of time for one complete oscillation, and, obviously, some time is required to build up to the full resonance value, and for this purpose it is necessary to allow 10 or more complete oscillations. Thus it is seen that in order to obtain the quickest form of signalling

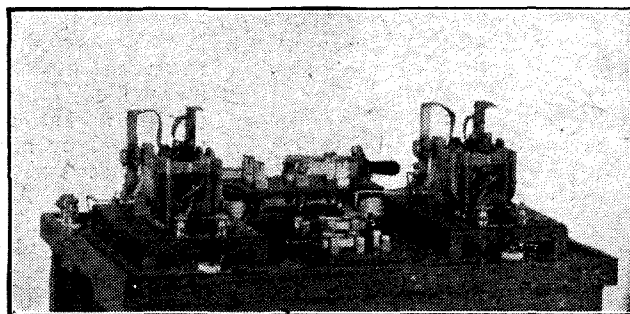

An automatic key, as used by the Marconi Co., Ltd., at their high-power commercial stations.

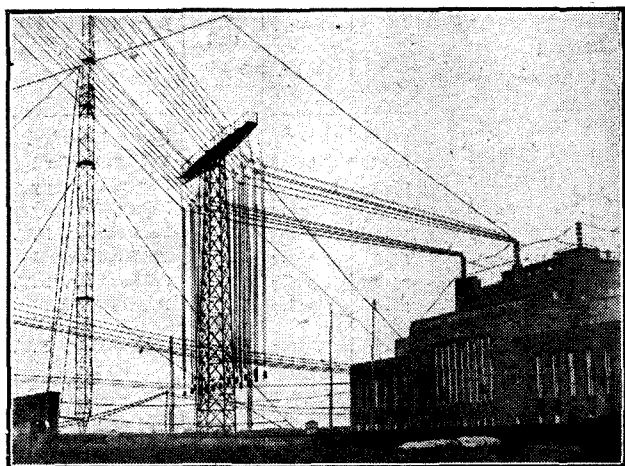

The down-lead of the main aerial at Nauen.

guaranteed throughout the whole year, the distance being 7,500 miles.

There is naturally a difference of strength between night and day, but this difference is not so great as that which is obtained on short-wave stations. For the Malabar to Holland service it is found to be better to use shorter waves by night than by day. The best wavelength by day is 16,000 metres (18.74 kc), and by night 7,500 to 9,000 metres (39.98 to 33.31 kc.). Atmospherics are bad on the long wavelengths which are used for these high-power stations, but much progress has been made in the way of minimising such disturbances.

The greatest objection, however, to the use of long waves is that it is impossible to put up the speed of signalling beyond about 50 words per minute. The reason for this can be very readily understood. It is that in order to appreciate a Morse signal there should not be too much distortion and that both dots and dashes must be fairly accurately reproduced. As the

it is essential to cut down the wavelength. The extent to which wireless has been used in recent years has made this problem of high speeds of signalling very pressing.

In the radiation formulæ already given, no attention was given to the effect of long distances on the radiation. In the early days of wireless it was very soon discovered that the ideas of rectilinear propagation of electro-magnetic waves had to be abandoned, for signals were being obtained around the curvature of the earth.

## Diffraction

This fact was very startling to scientists, who had expected that electro-magnetic waves would travel in straight lines. Their first attempt to explain why waves travelled around the curvature of the earth was obtained by an analogy with optics. There is an effect in optics called "diffraction," which means that light can be bent around the corners of sharp objects. Mathematicians attempted to explain on these principles of diffraction how electro-magnetic waves could be bent. In optics very little light is diffracted, and mathematicians soon discovered that the amount of electro-magnetic waves which could be diffracted, or bent, around the earth, was very small indeed. Their theoretical results on this basis gave signal strength at distances of greater than 1,000 miles of an order 500 to 1,000 times too small. According to their calculations on the diffraction theory, no signals would be heard at all at long distances. In other words, very much more energy was being sent around the earth than the diffraction theory could account for.

Almost simultaneously, Heaviside and Kennelly suggested that there might be a conducting layer some distance up in the atmosphere. This was an attractive idea to wireless engineers, for it immediately gave a suggestion as to why signals could be obtained at the



**Antipodes.** Various scientists took up this idea and attempted to explain how a conducting layer could exist at such a height in the atmosphere. Eccles put forward views which were widely accepted for many years, and which, with certain modifications, are still generally accepted in this country. These suggestions were that as the atmosphere is rarified at these great heights ionisation is produced by the sun's rays, particularly ultra-violet radiations, and thus, at a suitable height, there are large numbers of electrons and ions, thus providing a conducting layer. On this basis electromagnetic waves found themselves between two conducting layers, (1) the surface of the ground, and (2) the inner surface of the Heaviside layer, and thus, once electro-magnetic waves were produced they would be propagated between these layers.

**Austin-Cohen Formula**

Mathematicians did not attempt for a considerable number of years to develop this idea accurately in order to obtain quantitative values of signal strength at great distances, and it was left to practical engineers to work out a formula which would give the signal strength at considerable distances. The best known formula is called the Austin-Cohen formula, which modifies the formula given above by a factor which shows how the waves are diminished in strength as the distance increases. The received current  $I_r$  in an aerial is given in the following formula:—

$$I_r = AI_t \frac{h_t h_r}{\lambda d} e^{-0.0015d/\sqrt{\lambda}} \dots \dots \dots (1)$$

where A is a constant,  
 $I_t$  is the current in the transmitting aerial,  
 $h_t$  is the height of the transmitting aerial,  
 $h_r$  is the height of the receiving aerial,  
 $\lambda$  is the wavelength,  
 $d$  is the distance between transmitting and receiving aerials,  
 $e$  is the base of the natural logarithms,

Comparing this with the formula given last week for the received current which was

$$I_r = \frac{377 h_t h_r I_t}{R \lambda d} \dots \dots \dots (2)$$

we have the following differences:—In the present formula (1) all distances are expressed in kilometres, whereas in formula (2) all distances are in metres.

The constant A in (1) takes the place of the factor  $\frac{377}{R}$  in formula (2), which, of course, is constant for any one aerial for a given wavelength. It also allows for the change of units from metres to kilometres.

**An Attenuation Factor**

The important change is, however, the introduction of the quantity  $e^{-0.0015d/\sqrt{\lambda}}$  which is equivalent to an attenuation factor. This factor was, as already mentioned, determined from actual measurements, and the actual values have been the subject of much discussion. The fact remains, however, that it gives better agreement with actual results than any other formula, although no formula exists at present which gives any real interpretation of all the facts.

From this formula a little mathematical manipulation shows that there is a best wavelength for transmission over a given distance. For a distance of 1,000 kilometres the best wavelength, according to the formula, is 562 metres (53.40 kc.), and for the distance of 4,000 kilometres the best wavelength is 9,000 metres. In

actual practice, however, the optimum wavelengths are not given accurately by this formula, although there are best wavelengths. These discrepancies are due, first, to the fact that the formula is not quite accurate enough for all distances, and, secondly, to the fact that it does not take into account the very important features of differences between night and day transmissions.

**Atmospherics**

Then again there is the question of atmospherics to be considered, whose effect depends to some extent on the wavelength. Generally speaking, for long-distance communication the formula demands optimum wavelengths which are very large indeed, much larger than the wavelengths actually found to be best. We have seen that for the Malabar transmissions to Holland the best wavelengths have been found to be 16,000 metres

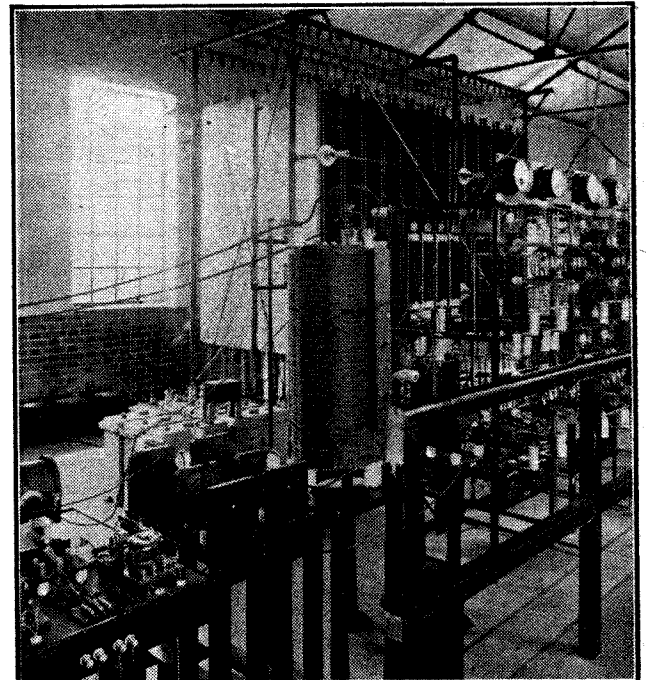

*A view in the transmitting room at the Ongar station of the Marconi Co., Ltd. The Ongar group of transmitting stations work on wavelengths between 2,950 and 5,100 metres (102 and 59 kc.).*

(18.74 kc.) for daytime working, and 7,500 to 9,000 metres (39.98 to 33.31 kc.) for night working, whereas the formula gives a value for the best wavelength many times greater.

**Day and Night**

This formula of Austin-Cohen was obtained as a result of practical measurements on a ship travelling across the Atlantic. It gave quite considerable agreement with practical results in various parts of the world at distances up to 2,000 miles. However, it was soon found that there were other variations; for instance, the difference between night and day signal strength, which could not be accounted for by the formula.

In the last few years attempts were made to obtain an accurate formula by the use of the Heaviside layer, and a rigid theory was worked out by Watson which agrees very favourably with the actual signal strength obtained at considerable distances.

The Heaviside layer is not the only expedient which has been suggested to account for the bending of waves round the world.

Various attempts have been made to account for this bending of the waves by considering that the properties of the atmosphere vary with height. The speed of propagation depends on the dielectric constant of the atmosphere, and if this is such as to increase the speed of the waves above the surface of the earth, a condition will be obtained when the waves bend actually round the earth.

### Properties of the Atmosphere

It will be necessary to account for the waves travelling more quickly in the upper layers of the atmosphere in order to keep in step with those lower down, as they have further to travel, being required to travel on a larger circumference. Of course, very little is



*One of the more serious objections to the long-wave station is to be found in the very elaborate engineering work involved by the large aeriels.*

actually known about the dielectric constant of the atmosphere at different heights. To start with, the atmosphere is not merely a mixture of oxygen and nitrogen, but it has other ingredients, such as water vapour, and again, at great heights, it is very doubtful what the actual constitution of the atmosphere is.

One scientist (Dr. Schwes) has shown that by considering the water vapour alone within the first three miles above the surface of the earth, the dielectric constant should vary in such a way as to cause the waves to follow the curvature of the earth. This theory was published in the Proceedings of the Physical Society of London in 1917.

The famous German wireless engineer Meissner has recently followed up this idea of the variation of the dielectric constant of the atmosphere to account for the bending of the waves round the earth, and has so con-

vinced himself of the possibility that he denies that it is necessary to postulate a Heaviside layer at all. He gives analogies with the case of visible light, which can be bent under certain circumstances.

### An Optical Effect

One example cited is that it is sometimes possible to see the shores of England from the summit of Mont Blanc, which is 450 miles away, and he argues that if light can thus follow the curvature of the earth, then electro-magnetic waves, which are of the same nature, should do the same. The phenomena of the mirage and the twinkling of stars are very similar.

In England most attention is given to the Heaviside layer theory. Various experiments have been suggested to attempt to prove this theory. There are various phenomena which need explanation. First of all, there is the fact that for long waves there is a difference between night and day signal strength. There is next the fact that as the waves become shorter, say in the neighbourhood of 300 to 400 metres (999.4 to 749.6 kc.), the day range and the night range differ very considerably.

On this range of wavelengths (200 to 600 metres, 1,499 to 499.7 kc.) there is a very considerable difference in daylight and night ranges. There is also the fact that fading occurs on these wavelengths, in other words that signals may be heard at one instant, and in a few minutes they will completely vanish, only to come back again later at some indefinite period. As the wavelength diminishes to 100 metres (2,998 kc.) the fading becomes very pronounced. Again, going still lower in wavelength, we find that in the neighbourhood of 20 metres wavelength (14,991 kc.) there appears to be a reversal of this effect, whereby day ranges are as great as or greater than the night ranges.

Some of the work in the following sections was suggested in order to test whether there is a Heaviside layer at all. On this theory, fading and difference in day and night reception are explained by the fact that certain waves are propagated upwards and other portions of the wave are propagated horizontally and are conducted along the surface of the ground. At a considerable distance these various components—some from the upper layers and some travelling along the surface of the ground—intermingle, and at times help each other and at times oppose each other, thus accounting for large variations in signal strength.

### Meissner's Explanation

Meissner's theory accounts for a somewhat similar effect, whereby there are ground waves and also waves which are shot upwards from the aerial and are quite free from the earth. These are sometimes bent down towards the earth to intermingle with the ground waves. In a similar way these can intermingle with each other and so produce strengthening or weakening of the waves. At very considerable distances the ground waves will be completely washed out, for the absorption of electro-magnetic energy by a conducting surface like the earth is considerable, and the ground waves particularly will be completely washed out at considerable distances, such as two or three hundred miles.

The whole of these discussions show how wireless has developed in the last two years, and it is interesting to note that everything has pointed to the fact that it is essential to propagate waves away from the surface of the earth in order to obtain long-distance communication. This applies particularly to short waves, and in next week's issue this question will be discussed.

# Some New Designs of Variable Condensers

*Several new types of variable condensers have made their appearance at this year's Wireless Exhibition, and a short description of a few of these is given here, together with some illustrations additional to those published in our Special Exhibition issue last week.*

**I**N view of the recent developments in design of low-loss variable condensers, we have made a special inspection of the various models shown at the Wireless Exhibition, and the following notes have been prepared for the benefit of readers who were unable to visit the Exhibition in person.

### A New Three-Electrode Variable Condenser

Messrs. Autoveyors have produced a new model of their bridge or balanced condenser, in which the control is centralised upon one spindle with concentric knobs. All the electrodes are mounted on one spindle, and the arrangement

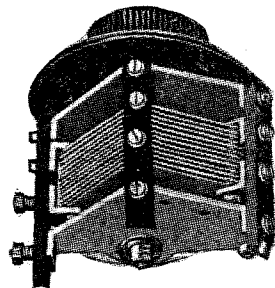

*The "Cosmos" Low-loss Square-law Variable Condenser.*

enables it to be mounted on the panel by the usual one-hole fixing method.

### A New Friction Drive Condenser

A new component has been produced by Messrs. Auto Sundries, Ltd., which is known as the Radiosun. This has special new features, among which is that of a friction drive giving a 50 to 1 reduction gear, thus facilitating fine tuning. The friction drive can be tightened up by means of the adjustments provided, and thus it is claimed that backlash is entirely eliminated. The indicating device consists of a pointer fixed directly to the moving vanes, this providing a direct indication of the condenser setting. A hinged scale is provided behind which a piece of paper may be placed, which may

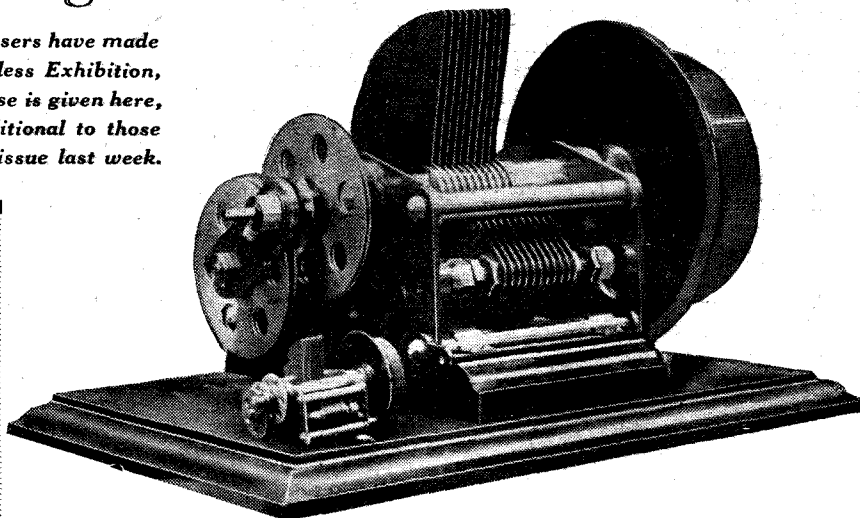

*A large working model of their geared variable condenser was shown by the General Electric Co., Ltd., with an instrument of normal size beside it.*

be used for recording the settings at which certain stations may be found.

### A New Geared Variable Condenser

An interesting new instrument is produced by the General Electric Co., and is being exhibited at their Stand. The dial, which is divided into two portions, enables the vernier and direct drive to be used at will, the upper portion providing the fine tuning. In this case again the dial moves in accordance with the moving plates of the variable condenser, and thus the vernier movement is registered automatically upon the dial.

### The Metro-Vick Low-loss Condenser

Another new variable condenser is that produced by Metro-Vick Supplies, Ltd., known as the Cosmos Low-loss Square-law Variable Condenser. We understand that this condenser gives a true square-law effect, and the design and construction reduce the losses to a minimum. The slow-motion models have a gear ratio of 10 to 1, and it is claimed that the method used ensures the absence of backlash. This instrument can also be used with a remote control arrangement, full instructions for which are contained in the carton.

### Polar Innovations

The Radio Communication Co. have produced a new variable condenser, known as the Polar Cam Vernier Condenser, which is of the compensated square-law type. In

this instrument both the fine movement and rough adjustment are made from the same knob, the vernier movement being registered upon the dial. Most of our readers will be familiar with the vernier arrangement in the Polar Cam Vernier Coil Holder, and it is a similar type of movement which is incorporated in this variable condenser. The dial of this condenser is graduated in a somewhat unusual manner, the maximum being marked 100 and the remainder of the scale divided evenly down to the minimum figure of 26, it being claimed that this corresponds to a

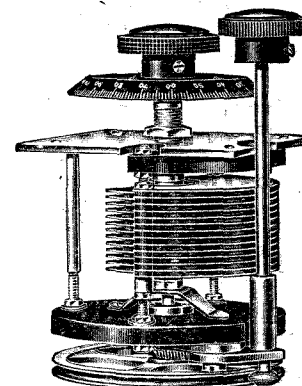

*The new Radio Instruments slow-motion condenser.*

tuning of 26 metres when a coil of such a size that it will give 100 metres maximum wavelength is used. A very low minimum capacity is claimed, and each condenser is sold with a printed guarantee of satisfactory performance.

**The Polar Junior Variable Condenser**

This condenser is modelled upon similar lines to the well-known Polar Mica Condenser, and is designed to fill the need for a cheap though efficient variable condenser. It is of the simple one-hole fixing type, and is provided with two terminals at the base, by which connection may be made to the external circuit. A very low minimum capacity is claimed for this instrument, and we also understand

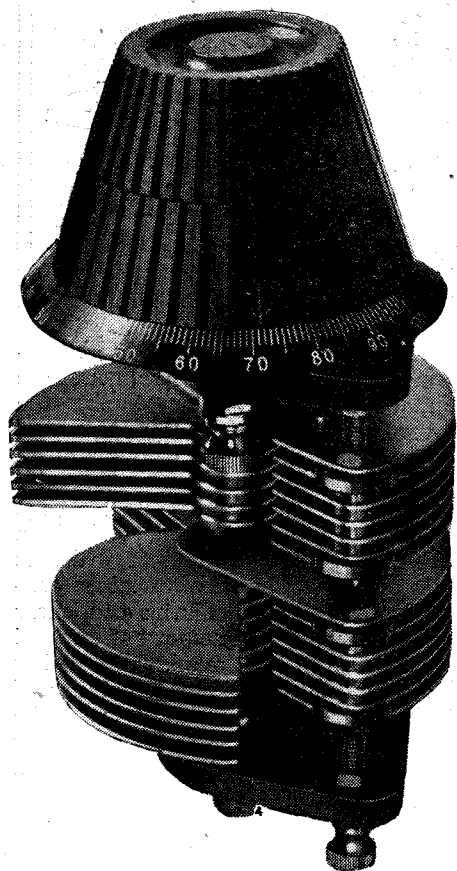

*Messrs. Autoveyor's new model of their three-electrode variable condenser.*

that the condenser gives an approximately straight-line frequency curve. It is totally enclosed in a dust-proof metal case, thus obviating the possibility of undesired noises due to dust collecting between the plates.

**The Radio Instruments Slow-motion Condenser**

Messrs. Radio Instruments, Ltd., exhibited a new geared type of variable condenser, which has a reduction ratio of 11 to 1. It is stated that the method of gearing is new and that it obviates backlash. The method of construction of the variable condenser is similar to that of their present models, the

vernier adjustments being made by means of a separate knob at the side of that giving the direct drive.

**The Bowyer-Lowe "Four-square"**

Messrs. Bowyer-Lowe Co., Ltd, were exhibiting their four-square con-

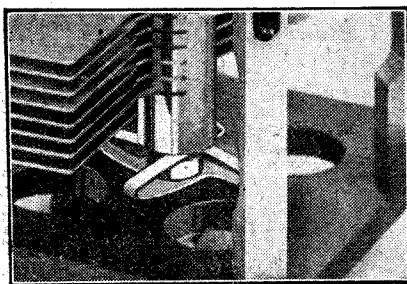

*Showing the lower spindle bearing in the Bowyer-Lowe "Four Square" condenser.*

denser, which will by now be known to many of our readers. This condenser may be used as a dual type of instrument, or, alternatively, the two halves may be put into series or parallel or either half used by itself. Thus it will be seen that a very wide range of uses is available for this instrument. At this Stand one may also examine the process of manufacture of these condensers from the very first stage to the finished instrument.

An interesting feature in this connection is the contact spring, which forms part of the lower spindle bearing. This is stamped out from the flat, and then has its four arms bent up in one operation, thus ensuring that the bends are made correctly and to a sufficient extent. The supporting pillars for the fixed plates are cut away, as seen in the photograph above, in order to reduce the minimum capacity by increasing the distance between the moving plates when in the full-out position and the upright supports.

**A VARIABLE CONDENSER TIP**

There are few experimenters who do not possess a variable condenser or two mounted in a small wooden case with terminals for external use in experimental work.

Such a condenser may be used to try the effect of tuning circuits where no provision is made normally for tuning, or it may be used in experiments on wave traps, for capacity reaction, and in experimental hook-ups of one kind or another, and is really a very valuable piece of apparatus to possess.

Frequently such a condenser is connected in a circuit where it is important that the moving plates be connected to the low potential side in order to reduce hand capacity effects. For instance, it may be employed in a selective low-loss circuit, in which position, if not correctly wired up, tuning becomes extremely difficult. When receiving a distant transmission, all may be well till the hand is removed from the condenser knob, whereupon the station vanishes.

It is necessary, therefore, to mark in some way the terminal which is connected to the moving vanes. The simplest method of doing this is to use a transfer of an arrow, which may be applied so as to point to the terminal which is wired to the moving spindle of the condenser. This is easily done with the aid of a Radio Press panel transfer, and there is then no doubt as to which terminal is which.

When used as a series aerial condenser, the aerial will be connected to the fixed plates, in a grid circuit the moving vanes are connected to L.T., and in an anode circuit to H.T.+

This scheme reduces hand capacity effects in normal circuits to such proportions that little trouble is experienced except on the very short waves, in which case, of course, an extension handle may be needed.

C. P. A.

**AT THE WIRELESS EXHIBITION**



*The receiving apparatus supplied by Messrs. Radio Communication Co., Ltd., for the use of liners, the battery charging board being seen on the wall above the receiver.*

## WHY DULL EMITTER VALVES ARE SILVERED

*In addition to its action in cleaning up the vacuum, the "gettering" of a valve has a further important function which is described in this article.*

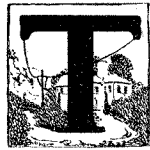
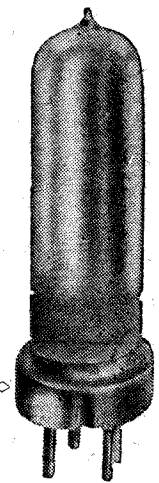
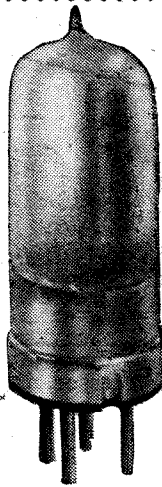

HERE are many processes which are used in the exhaustion of valves of various kinds. In the old days of bright emitter valves the bulb, when the valve was completely evacuated, was perfectly clear. When dull emitter valves came into use, however, the great majority were provided with silvered bulbs, and this type of bulb is now practically universally used for any dull emitter valve—at any rate, for the type having a thoriated filament.

### Removing Occluded Gases

It is well known that this silvering of the bulb arises during the exhaustion process of the valve, but there are one or two points in connection with the process which are of considerable interest.

In the first place, owing to the necessity in dull emitter valves for removing all traces of water vapour, carbon monoxide, and other gases which are present in the ordinary air, and which are fatal to the formation of the thoriated filament, a certain "getter" is introduced into the bulb just prior to the exhaustion process. This getter consists of some metal or element which readily combines with the particular gases to be eliminated, and when the valve is heated up during the exhaustion process, it volatilises and rapidly combines with any spare traces of impurity in the vacuum.

### Discoloration of Bulb

The getter then deposits itself all over the bulb, so producing a discoloration of the glass. If the substance used is magnesium metal, as is very often the case, the bulb takes on a silvered appearance, or

if some other getter is employed, the discoloration will be different. One particular case of this is the substance employed by the B.T.H. Co. for some of their valves which produces an amber discoloration.

### Grid Current

This use of the getter to assist in the evacuation process is comparatively well known. There is, however, another use for this magnesium getter which is rather subtle and is not by any means so widely known. There are several processes in which a valve is employed for which it is necessary that a certain grid current shall flow. One such case in point is when the valve is used as a detector with the cumulative grid method of rectification. This method, of course, depends upon the minute grid currents which flow every time the grid is positive to the filament, so charging up the grid condenser.

### Working Point on Characteristic

Now the working point on the characteristic of the valve depends

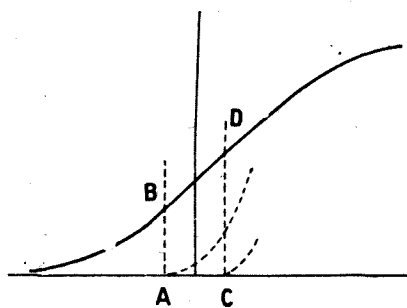

Fig. 1.—Illustrating the effect of grid current on the working of a valve.

upon the grid-current characteristics. Referring to Fig. 1 it will be seen that if the grid current lifts at the point A—that is to say, with a slightly negative grid voltage—the working point on the anode current for this voltage characteristic

will be somewhere in the neighbourhood of B.

Similarly if the grid current lifts at a point such as C, say slightly positive, then the working point on the anode current characteristic will be somewhere in the neighbourhood of D. Actually, of course, the working point on the characteristics is not quite as indicated, because the presence of the gridleak causes a small permanent grid current to flow, and this means, therefore, that the working point on the characteristic will actually correspond to some point where there is a small grid current and not at the actual point where the grid current is zero. This difference, however, is of comparatively minor importance.

### Grid Electro-Positive to Filament

The important point is that if the grid current is to commence to flow at a reasonable value of the grid voltage and not one which is excessively positive, it is necessary that the grid should be electro-positive to the filament. All metals have a certain potential relative to each other, and the difference in the potential between any two metals is called the contact potential between them. It is found in valve design that if the grid current is to commence to flow at a value suitable for normal operation the grid should be electro-positive to the filament by a certain amount, which depends upon the temperature of the filament and other details of that nature. With the normal bright emitter valve having a filament of tungsten and a grid of molybdenum or nickel, this condition is usually

(Continued on page 25.)



### Home, Sweet Home



ALL things must have an end. This is strikingly true of both cash and holidays. For some time, as I have already told you, Professor Goop, Poddleby and I kept ourselves going on the Continent by means of lectures delivered by the eminent scientist. For some weeks we drew crowded houses, and we prospered accordingly. The Professor, however, is far too good natured, as you will have realised before now, and he found himself quite unable to say "No" to any applicant for a free ticket. This fact having become noised abroad, it was not long before the entire audience had provided itself with complimentary vouchers from the great man.



... Selling the Professor's autograph ...

Lecturing to a crowd of deadheads is doubtless noble and unselfish work, but it does not help enormously towards paying one's hotel bill. These things being so, we decided that the season abroad was nearing its end, and that it behoved fashionable folk like ourselves to make tracks once more for home. As we all had return tickets, there was no difficulty about doing this, though cash had run rather low. However, Poddleby and I did fairly well by selling the Professor's autograph to Americans at ten francs a time. We might even have prolonged our stay for another week by this means had not some of our clients discovered that the Professor apparently signed his name in two entirely different ways, and begun to ask awkward questions. It is unfortunate that Poddleby's handwriting should be so dissimilar from mine, but I was able to quell the brewing storm by explaining that the Professor wrote with both hands.

### The Departure

On the morning of our departure Poddleby and I arranged to go on first to the station with the luggage. We also took the precaution of carrying with us the available supplies of cash with the exception of five

francs. These we left with the Professor, instructing him to distribute them as largesse amongst the hotel staff. We thought that tips would come better from him than from us. The Professor was trembling like an aspen leaf when he reached the station only a minute or two before the train went. He described in vivid terms the horror of his progress through the hall of the hotel to the door between the ranks of expectant servants from bootboy to head waiter. Not knowing what to do he handed the five francs to the first person he saw—this he realised later was Professor Funk, who had come to say farewell—and fairly ran for it. He had also to run for the train, since we had forgotten to leave him a small surplus for his taxi fare. The journey home would have been without incident had the Professor's great brain not suddenly started working. As we were flying along at heaven knows how many miles an hour, he rose and, without a word of warning, pulled the communication cord. He explained later that he had been struck with an idea for an entirely new type of safety device, and in the meantime he wished to see whether these things worked as efficiently in France as they do in England. This one certainly worked all right. The brakes went on with a jerk that dropped my two suit cases neatly on to the head of the sleeping Poddleby, and in a moment the carriage was filled with officials, each

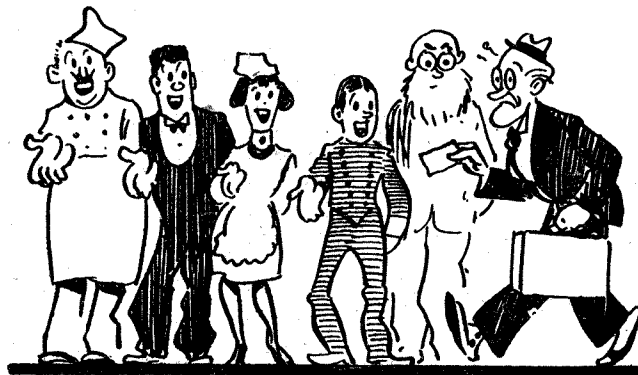

... We left five francs with the Professor to be distributed as largesse ...

of whom seemed to be trying to shout louder, to talk faster, and to gesticulate more wildly than all the rest. It was only by explaining that the Professor, walking in his sleep, had mistaken the communication cord for an aerial halliard, and by distributing our entire remaining funds, that I was able to straighten matters out.

### A Welcome!

Before leaving I had taken the precaution of getting my Yogu-Toblazian medical friend to write from

Kastoff to the Office, saying that I was now practically recovered from my terrible accident, and might return to do light work. I got him to underline the "light" three times. On the way to the Office I applied sticking plaster cunningly to various parts of my face, and having been helped out of the taxi by the driver and two kindly policemen, I limped in, a very passable imitation of an ex-stretcher case. "Bonjour, mes vieux," I said in a weary voice. . . . "Oh, I beg your pardon, I was forgetting that I was in England. How are you, my dear fellows?" Somebody gave a grunt, but the rest simply went on working. Something had to be done. I slapped Mr. Mousee heartily upon the back, which caused him to jump so satisfactorily that his inkpot landed in the midst of his opposite number's waistcoat. And then they all began to talk at once. I was back at last, was I? And about time too. And all sorts of things of that kind. With a little resigned sigh I told them that they must have been overworking in my absence, and left the room in search of Mr. Hercy Parris. He, at any rate, I felt sure, would give me a proper welcome.

**The "Splash"**

"Hullo, Hercy," I said when I had found him, "I am not really fit to come back yet, but though the doctors tried to keep me in hospital, I simply insisted on returning to work." "What's the matter with your face?" asked Mr. Parris. "Been playing the bone in a dog fight?" "Surely," I said, "you heard from my friend in Yugo-Toblazia, Dr. Pzrschoff? He wrote every day to report my progress whilst I was in hospital, and his final letter despatched two days ago reported that I was fit for light duty." "Oh, yes," said Mr. Parris, "he wrote all right. But he used a French stamp and the postmark was Trouville." This was rather a facer, but I was not done. "All Yugo-Toblazians," I said, talking rather quickly, "send their letters to friends in France to post. You see, they save a lot by doing that, for



. . . Professor Goop, Mr. Poddleby and friend taking their morning dip . . .

a stamp in Yugo-Toblazia costs eight million snitchers, and in France . . . ." "Wait a minute," said Mr. Parris. He opened a drawer, and produced from it a two days old copy of the *Daily Splash*. Turning to the middle page he placed his forefinger upon a picture, and passed it across to me. Beneath the picture I read:—

**"CELEBRITIES AT TROUVILLE.**

"Professor Goop, Mr. Poddleby and friend taking their morning dip."

There was no doubt about it; it was us all right. The Professor and Poddleby were a good deal blurred,

but there was no mistaking myself. I was too stunned even to resent the insult of "and friend." I handed back the picture, smiling rather wanly.

**A Hectic Time**

"It is a pity," I said, "that the *Splash* should have got hold of this." "Isn't it?" asked Mr. Parris grimly. I held up my hand. "Let me tell you all," I said. "Directly the Professor, Poddleby and I had set foot upon foreign soil, we realised that we were being followed. By making cautious inquiries and keeping a most careful watch we discovered that a gang had planned to abduct the Professor and to extract from him, under torture if necessary, details of his latest and most secret invention. We have had

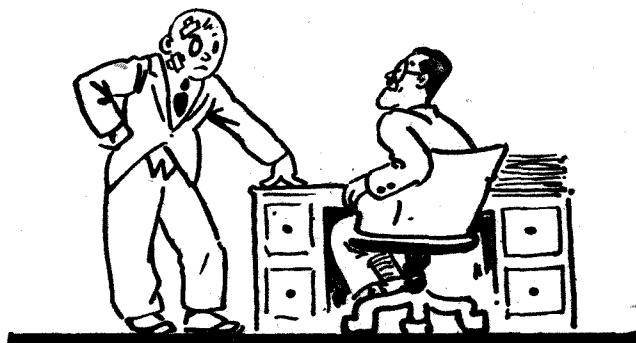

. . . began to ask me awkward questions. . . .

to keep constantly on the move in order to throw them off the scent. We led them to think that we had gone to Kastoff. We simply could not return, since gunmen were watching all the ports for us. Just a week ago the entire gang was arrested by the police, and we retired to Trouville in order to restore our shattered nerves. It has been a hectic time."

"H'm," said Mr. Parris.

"Of course," I went on, "I was engaged all the time in conducting my investigations into the wireless conditions upon the Continent. I have returned with a mass of valuable matter."

**All's Well . . .**

At this point Mr. Parris stirred himself and began to ask me a lot of awkward questions. Not having so far had time to read the French wireless papers, which I had bought on the journey home, I was a little short of facts. I therefore pleaded that I had seen so much and had collected such a mass of details that I could not possibly keep them all in mind. I did, however, mention that the French seldom use crystals for reception of telephony at more than a hundred miles, and that the loud-speaker is more popular in that country than headphones at wireless dances. If these things are mentioned next week in "Random Technicalities" you will know where he got his information. At this point I deftly changed the topic by asking Mr. Parris to tell me something about his latest set, "The Nerve-soothing Nine." That did it. Mr. Parris talked nineteen to the dozen and covered simply reams of paper with drawings and diagrams. "And now," I said at length, looking at the clock and remembering that if I was broke Mr. Parris was probably not, "let's go and have lunch." We went.

**WIRELESS WAYFARER.**

# WHEN TO USE A LOW-LOSS COIL

By G. P. KENDALL, B.Sc., Staff Editor.

*To obtain the full benefit from the use of a low-loss coil it is necessary that it be employed at a suitable point in the receiver. These notes are intended to give a clear understanding of the limiting factors which govern the use of such inductances in normal types of circuit.*

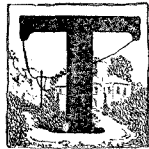

Anyone who has advocated the need of greater efficiency in our tuning coils as persistently as the present writer, it is a great satisfaction to see the widespread adoption of the low-loss idea in relation to coils, but there is yet a possibility of some disappointment in the use of these improved tuning inductances unless certain fundamental facts are grasped in relation to their functions.

## Possibilities of Disappointment

We have seen something of this sort happen in the case of the low-loss variable condenser, for most of us have now discovered for ourselves that if we replace any good normal type of variable condenser with one of the latest low-loss type, in quite a number of circuits we shall discover that little, if any, improvement results. The resulting disappointment has led some people to wonder whether there is anything in the low-loss idea at all. Now, this is simply a case of not being able to see the wood for the trees, the trouble being that we have not in many cases devoted sufficient thought to the matter to realise that the losses in the particular component we were considering were not the only ones in the circuit.

## Loss Ratio

The most obvious example, of course, is to be found in the aerial circuit, where the total high-frequency resistance may be really quite large, and where the actual

proportion of it represented by the variable condenser is practically negligible (I am speaking, of course, of the broadcast frequencies only). This one example will suffice to draw the reader's attention to the fact that there are certain circuits in which there are other losses of so

say, No. 24 gauge wire, further improvements usually have little effect upon signal strength and selectivity. It would therefore seem to be indicated that a coil of reasonably good design should be used in the aerial circuit, but that no very elaborate efforts should be made to secure the best possible low-loss effect.

## A Promising Field

The more promising circuits from the point of view of the reduction of losses are undoubtedly the secondary and inter-valve circuits, so long as they are not tightly coupled to such a high-loss circuit as the aerial system. Thus, the secondary of one of the popular "aperiodic aerial" arrangements presents a good field for improvement, and here the very best of low-loss designs is worth using.

Our main object in seeking "low-loss" is to sharpen the peak of the resonance curve of the circuit in which we are endeavouring to reduce the losses, with a view to improving the selectivity of the receiver and increasing signal strength to some extent. We have seen that the aerial circuit is not a suitable place for such improvements, since the coil losses do not form a sufficiently large proportion of the total circuit losses, and we therefore turn our attention to such circuits as the secondary of a loose-coupled tuner, intervalve circuits, and so on. This statement in itself needs some qualification, lest it be imagined that any circuit which is separated from the aerial circuit to

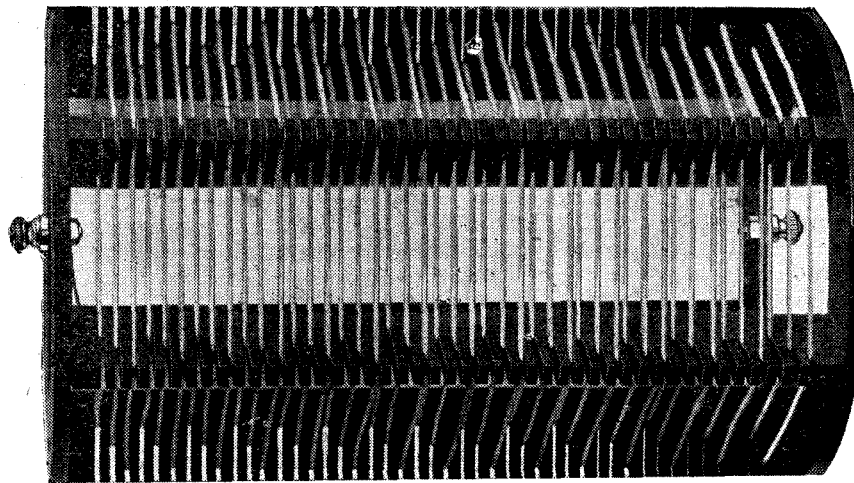

*One of the latest low-loss coils: the "Three-step" coil described by Mr. Kendall in the first number of "Wireless."*

great a magnitude that they swamp to a large extent the losses taking place in the tuning coil and the associated variable condenser.

## An Example

The aerial circuit is a good example of one in which discretion should be used in carrying out the low-loss idea in the tuning coil, and a general rule can be laid down that with the great majority of aerial and earth systems the other losses due to earth resistance, radiation resistance of the aerial, and all the other factors which result in a high value of high-frequency resistance, to a large extent swamp the losses in the tuning coil. By the time as high a degree of efficiency has been obtained in the tuning coil as will result from the use of a simple single layer coil of,



a sufficient extent is a suitable place for low-loss development.

**Grid Current Damping**

The recent work of Mr. Cowper, published in this Journal, has clearly demonstrated that the damping produced by the grid current of a rectifying valve working on the grid condenser and leak principle may be, and usually is, sufficient to produce a decided flattening of tuning. This effect may be regarded as equivalent to that of a series resistance of quite considerable value, ranging from about 40 to 80 ohms in many cases. Where so high an equivalent resistance obtains it is evident that the reduction of coil losses below a certain point will produce little improvement in results. It will thus be seen that we must add to our first generalisation a further one to the effect that where we have connected across the circuit a valve with a considerable grid current, it is useless to employ ultra low-loss tuning inductances.

**Practical Applications**

Let us see how these principles work out in practice, taking a common type of circuit as an example. In Fig. 1 will be found a three-valve neutrodyne circuit of a quite conventional type, employing one high-frequency valve, detector and one note magnifier. Here there is an untuned aerial circuit in which the coil  $L_1$  is connected, thus forming what is commonly called an "aperiodic aerial circuit." There is little point in reducing the losses in the coil  $L_1$  below a certain very easily achieved point, and any such construction as a simple basket coil with, say, No. 22 gauge wire, will serve perfectly well here. The coil  $L_2$ , on the other hand, is situated

in a circuit where the damping can be extremely low, provided that there is only a moderate degree of coupling between the secondary circuit and the aerial circuit, and also with the further proviso, that the first valve shall be so adjusted as to function without perceptible grid current.

coupling circuit, in which we find the coil  $L_3$ , it is at once apparent that we have here the factor of grid current damping, since the second valve is the detector and considerable grid current flows. The coil  $L_3$ , therefore, will not repay careful design to such an extent as will take place with  $L_2$ , and here quite a moderately efficient design will serve. For example, Mr. Cowper has shown that an ordinary single layer winding of moderate gauge upon either a carefully dried cardboard tube or a thin ebonite tube, will give results which very closely approach those of the best low-loss design.

**A Neglected Point**

The winding  $L_4$ , which comprises the neutrodyne coupling winding, is one which has been curiously neglected as a possible source of loss in the grid circuit of the first valve, and it seems to me that this should receive a greater amount of consideration. In the way in which I have drawn the circuit it will be quite clear that this winding  $L_4$  in series with the neutralising condenser is connected in parallel across the ultra low-loss circuit in which  $L_2$  is located, and it is evident, therefore, that imperfections in the winding  $L_4$  may result in an appreciable addition to the losses present in this circuit.

**Reducing Grid Current Damping**

The effects of grid current damping and their influence upon the design of a circuit as regards losses is one which is likely to receive considerably more attention

in the future than has been devoted to it in the past, and upon another page of this issue will be found an interesting article from Mr. Cowper showing that one of the usual schemes adopted to reduce these losses, namely, the tapping of the

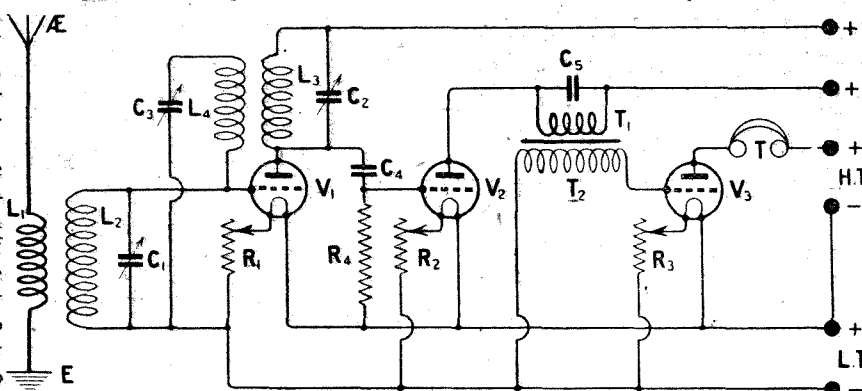

Fig. 1.—In this circuit the coil  $L_2$  may be of the ultra low-loss type, while little advantage will be derived from a reduction of the losses in  $L_1$  below an easily reached value.

**Necessity for Neutrodyning**

Under conditions such as these, of course, the provision of a tuned anode coupling between this valve and the next valve would naturally lead to considerable trouble from self-oscillation, and therefore one of the common types of neutrodyne arrangements is shown. Granted, then, that the coupling between the aerial and secondary circuit is not too tight, and that a neutrodyne

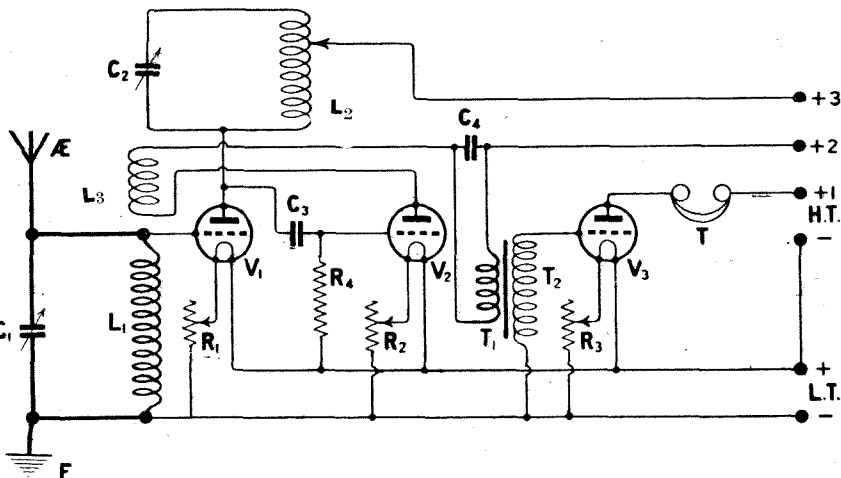

Fig. 2.—The use of a tapping upon the coil  $L_2$  provides a method of reducing the damping produced by the grid current of the detector.

arrangement is provided so that the grid of the valve can be kept fully negative, it follows that the design of the coil  $L_2$  is well worth study. Here an ultra low-loss inductance is worth while.

**Intervale Circuits**

Turning now to the inter-valve

(Continued on page 27.)

# The Problems of Absorption and Fading

By J. H. REYNER, B.Sc. (Hons.), A.C.G.I.,  
D.I.C., Staff Editor.

*This is the second article of the series which is being specially written to provide our readers with a clear idea of modern theories concerning wave propagation.*

**I**n my previous article I discussed the various theories which had been put forward to account for the fact that wireless waves would travel round the curved surface of the earth. These theories, it will be remembered, were briefly as follows:—

One school of thought suggests that the electric waves are reflected at an ionised layer of gas in the upper atmosphere, at a height of about one hundred kilometres above the earth's surface. A second school of thought suggests that the waves are not reflected at this layer, but are refracted, that is to say, caused to bend round at this layer, and so return to earth; while the third school of thought suggests that bending round the earth's surface is solely due to a change in the di-electric constant of the atmosphere, which occurs comparatively close to the earth's surface, and therefore that the Heaviside layer is not required to explain the bending at all.

## Absorption

We will consider this week some of the other problems which present themselves in the transmission of wireless waves round the world. Of these, two of the most important are the problems of absorption and fading. It is well known that wireless waves do not travel unhindered. In the process of their passage round the earth they are attenuated by some means or other, the result being that the signal strength at the far end is considerably less than one would expect from the simple theoretical formulæ.

Dr. Robinson, in his article last week, gave formulæ showing the received currents which one would expect in a receiving aerial if there were no attenuation or absorption. It is found, however, that the actual signal strength is considerably less than this, and various formulæ have been put forward from time to time, most of which were arrived at as a result of practical tests, in order to allow for this absorption which is known to be occurring.

I do not propose in this article to discuss these various formulæ, beyond remarking that all those which have so far been proposed have not been particularly successful under the majority of conditions. A formula which is useful for a wavelength range of, say, 600 to 4,000 metres (499.7 to 74.96 kc.), is quite inadequate for wavelengths of 10,000 to 20,000 metres (29.98 to 14.99 kc.), and in the past the design of long-distance transmitting stations has been very much on the lines of getting as much power as possible in the aerial at the transmitting station, and hoping for the best.



*Electrons are much smaller than atoms. The lightest atom known (hydrogen) has 1,800 times the mass of an electron. The proportion is as the dome of St. Paul's is to a halfpenny.*

## Ionic Displacement

The original Heaviside layer theory assumed the electrified layer to be composed of ions, which are atoms from which some of the negative electrons have been removed, so leaving a comparatively heavy positively-charged body. The wireless waves, in travelling through this medium, would cause the ions to vibrate somewhat in the same way as electric currents are induced in a receiving aerial placed in the path of the waves. This vibration of the ions naturally abstracts some energy from the waves, with the result that the wave is attenuated, or reduced in strength.

The theory was that during the daytime the Heaviside layer was irregular, and, moreover, the ionisation of the air due to the sun's rays extended considerably lower than at night. Consequently during the day the waves encountered a large number of these positive ions, and the result was that the absorption was comparatively heavy. At night, however, it was thought that the ionisation nearer the earth's surface disappeared when the sun's rays were absent, with the result that there was a more or less well-defined layer of ionised gas which acted more as a pure reflector, and consequently the absorption was not as heavy.

### Varying Velocity

Ordinary reflection and refraction effects, however, depend, to a large extent, upon absorption, and it was pointed out that, in order to produce sufficient bending by this simple theory, the absorption would have to be so great as to reduce the strength of the wave almost to zero.

Eccles then proposed that the velocity of the waves could be changed in an electrified medium, which

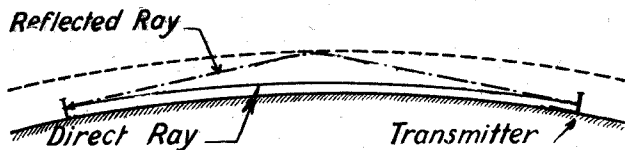

Fig. 1.—Fading is thought to be due to interference between two waves arriving at the receiver by different routes.

would cause the waves to bend round in a somewhat similar manner to that explained last week in dealing with the Meissner theory.

### The Larmor Theory

This theory was not satisfactory, however, from many points of view, and it seemed that a deadlock had been reached, until Sir Joseph Larmor recently put forward certain further modifications which completely altered the position.

The two principal modifications were the substitution of electronic vibrations for ionic displacements, and a somewhat different conception of the mechanism by which the velocity of the waves in the electrified medium is increased, so giving rise to bending.

This theory is capable of providing reasonably sound explanations of the observed phenomena, and has aroused considerable interest. We will consider some of the effects in greater detail.

### Ionisation by Collision

If an electron is caused to move with a considerable velocity, and in doing so encounters an atom, it will ionise this atom, that is to say, it will knock one of the electrons in this atom out of its course, and so leave the atom ionised. This, of course, requires an expenditure of energy, and it is suggested that it is this ionisation of the other atoms which causes the absorption from the wave.

In defence of this theory, it is pointed out that very short waves such as are now being employed do not suffer absorption to anything like the same extent as the longer waves. It is found that with normal waves, that is to say, waves from 300 up to 20,000 metres (999.4 to 14.99 kc.), the longer the wavelength, *i.e.*, the lower the frequency, the less is the absorption. This almost follows from the dictates of common sense, if the theories which have just been considered are assumed to be correct.

The less rapid the vibration of the ether waves, obviously the less opportunity there will be for this ionisation by collision, due to the response of the free atoms in the upper atmosphere. So far, therefore, we are in accordance with the observed facts, namely, that as the frequency increases, that is to say, as the wavelengths get shorter and shorter, so the absorption increases to a fairly marked degree.

### Absorption Less on Very Short Waves

It is found, however, in practice, that with very short waves of the order of 100 metres or less, the absorp-

tion appears to be almost non-existent, and the remarkable ranges which have been achieved in the past year or two indicate that these waves are travelling almost unfettered through the ether. It is suggested, to account for this phenomenon, that the "mean free path" of the electron is coming into play.

The mean free path of an electron is the average distance it will have to travel before it meets an atom of gas which it can ionise. The length of the mean free path depends upon the pressure of the gas. At normal atmospheric pressures—*i.e.*, at the earth's surface—the mean free path is very short indeed, and if an electron is set in motion, it has no time to acquire a reasonable velocity before it meets another atom. The electron, therefore, cannot ionise the gas because it has not acquired sufficient velocity.

As the pressure is decreased, however, so the mean free path increases, the electron gathers speed, and ionisation becomes possible. In very rarified atmosphere, on the other hand, the mean free path of the electron becomes so long that it is quite possible for the electron to travel for a considerable distance without ever meeting an atom.

### Travel of the Electron

Now the actual travel of the electron will obviously depend upon the frequency of the vibration. The higher the frequency the shorter the time the electron has to complete its oscillation, and thus the shorter the travel. It is suggested that at the very high-frequencies corresponding to wavelengths of 100 metres or so, the travel of the electron is less than the mean free path at the particular height of the Heaviside layer. The result is, therefore, that the electron is merely oscillating in free space and never, or very rarely, meets with an atom of gas which it can ionise, so that the absorption is almost negligible, the only energy extracted from the wave being that required to keep the electron in oscillation. This again appears a plausible explanation of the state of affairs.

### The Effect of the Earth's Magnetic Field

The theory, moreover, is borne out by a most interesting development which was recently brought to light by Messrs. Nichols & Schelleng, in America.

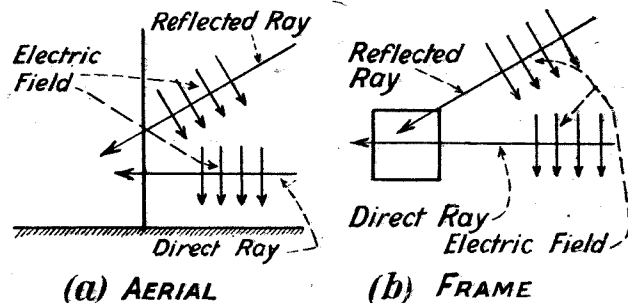

Fig. 2.—Illustrating the effects of the direct and reflected rays at the receiving point.

This development was reviewed briefly in the "Inventions and Developments" column some time ago (*Wireless Weekly*, Vol. 6, No. 18). These two investigators have shown that the effect of the earth's magnetic field on the vibrating electrons in the upper atmosphere is to cause them to vibrate in an elliptical orbit instead of straight up and down. More important still, however, they show that due to this magnetic field there will be a particular *resonant*

frequency, at which point the vibration of the electrons will suddenly increase enormously, so that at this point the travel of the electrons far exceeds the mean free path. This will result in almost total absorption.

### Bad Transmission on 200 Metres

They then followed up this theory by substituting in the formula the value of the earth's magnetic field, and they obtained the surprising results that this natural frequency of the electron was in the neighbourhood of 1,400 kilocycles per second, corresponding to a wavelength of 214 metres. Now it is a fact which has been established in practice that most peculiar effects occur in the neighbourhood of 200 metres, and communication on this wavelength and a little over is difficult to accomplish over anything like a long distance. This, therefore, would appear to be almost direct proof that the theory of electron displacement was correct in accounting for absorption.

### Fading

The latest researches, moreover, seem to favour the Heaviside layer theory, despite the arguments of Meissner. This is particularly emphasised in a paper given by Professor E. V. Appleton before the British Association at Southampton, describing the work done at Cambridge by himself and Mr. Barnett on the subject of fading.

According to their theory the electric field at the receiving station is made up of two components, one of which has arrived via the direct path along the surface of the earth, while the other has arrived by reflection from the Heaviside layer. Fig. 1 illustrates the two waves at the receiving point.

### Interference

This theory in itself is not new, having been formulated by other investigators some years ago. The present development, however, shows that, owing to changes taking place in the upper atmosphere, these two waves may sometimes be in step or "in phase," to use the technical term, while at others they may be out of phase. Thus the resultant signal strength will be varied depending upon the relative phases of the direct and the reflected waves.

The phase differences between the two waves are due to a twisting effect, which occurs to the reflected ray. This point will be referred to in greater detail next week.

### Effect of Distance

The extent of the fading depends upon the distance of the receiving station from the transmitter. If the two stations are fairly close the direct wave will preponderate, and the effect of the reflected wave will be to cause slight variations only, while at medium ranges, where the direct and reflected rays are about equal, the fading will be very marked.

In long-distance communication, however, particularly with short waves, the direct ray is to all intents and purposes non-existent. In such cases there are two possible theories.

One is that interference is obtained between two reflected rays arriving at different angles. The other theory is that the energy is arriving in some sort of beam and only reaches the ground in certain areas.

It would seem that the two conceptions are merely different views of the same phenomenon, for the effect

of interference, as suggested in the first hypothesis, would be to produce bands of good reception alternating with blind areas.

### Loop Fading Greater than Aerial Fading

These effects are to a certain extent borne out in practice, but there is little, so far, to indicate that this theory is any more correct than the others which might be put forward.

On this theory, however, Appleton has shown that the fading effects obtained with a loop or frame aerial are greater than would be obtained with a simple "open" aerial.

### Practical Verification

Experiments conducted at Cambridge indicate that this is actually the case in practice, so that the theory is amply verified by practical evidence.

Moreover, from the experimental results, the actual angle at which the reflected wave is arriving can be measured. For example, the reflected wave from 2LO arrives at Cambridge at an angle of about 60 deg.

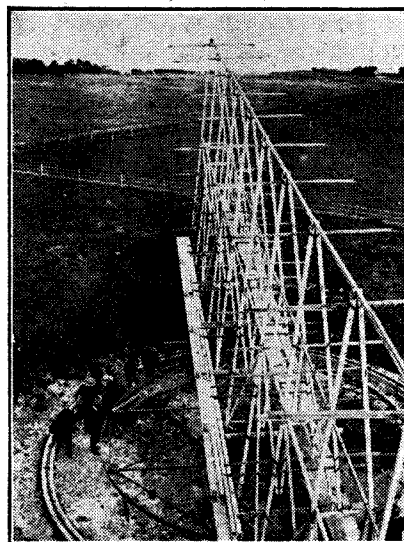

*The Marconi  
"lighthouse" at  
the South Fore-  
land, seen from  
above.*

### Both Theories Correct?

These results obtained by Professor Appleton therefore seem to indicate fairly definitely the presence of some reflecting or refracting layer at a considerable height above the earth's surface. From the figures which they have obtained they are able to deduce the actual height of this reflecting layer, and the results agree well with the previous estimates—that is to say, about 100 kilometres.

It should be observed, however, that this theory also requires a direct ray which is required to travel round the earth's surface, and it is possible that here the Meissner theory may be of assistance in explaining how such a direct ray is possible over distances for which the curvature of the earth is appreciable.

Next week I shall consider some other aspects of the problem, dealing with the concentration of energy at the Antipodes, a factor which assists in the very long-range transmissions, and I shall also refer to the rotation of the waves in their transit from one point to another.

# Wireless News in Brief.



On September 11 a large gathering of Wireless and Press representatives met at a luncheon at the Savoy Hotel, at the invitation of the National Association of Radio Manufacturers and Traders, to celebrate the thirtieth anniversary of the invention of wireless telegraphy. The guest of honour was Senatore Marconi, while there were also present: Mr. W. W. Burnham (Chairman of the N.A.R.M.A.T.), Sir Herbert Blain, Mr. J. C. W. Reith (Managing Director of the B.B.C.), and Captain Ian Fraser, M.P.

In case the notice on this subject issued lately may have escaped attention in some cases, owing to the holiday season, the Postmaster-General wishes again to point out that the legal obligation to take out a licence for a wireless receiving set—whether crystal or valve—has been placed beyond any doubt by the Wireless Telegraphy (Explanation) Act. The Postmaster-General trusts that any persons who have failed hitherto to take out licences will do so at once; and he thinks it right to repeat that he proposes in future to institute proceedings in cases coming to his knowledge in which wireless sets are installed or used without licences.

Wireless receiving licences can be obtained on application at any Post Office at which money order business is transacted, on payment of the annual fee of ten shillings.

\* \* \*

An interesting exhibit at the Wireless Exhibition is on the Marconi stand. It is the microphone which has been made for the King's exclusive use.

Covered in silver gauze and decorated beautifully with symbols in silver by the Goldsmiths Company, the microphone has on it a silver plate upon which is engraved every occasion and date upon which it is used.

\* \* \*

We are informed that police forces in different parts of the country are about to follow the example of Scotland Yard in the use of wireless for catching criminals.

For more than a year Scotland Yard has recognised the value of wireless, and several motor-vans used by the flying squad have got beyond the experimental stage and are being used in expediting the pursuit of criminals.

To prevent the leakage of information into wrong channels a secret code is used by the police.

\* \* \*

Radio-telephony is to be brought into general use for co-operation between troops and aeroplanes at the forthcoming Army manoeuvres, and an opportunity will be provided for proving its practicability under active service conditions.

Each divisional headquarters will be accompanied by a tender carrying a receiving set for the reception of radio-telephonic messages from the air.

Successful two-way radio-telephone communication between aeroplanes and the ground was established for the first time in the U.S.A. anti-aircraft test manoeuvre just concluded at Fort Tilden. In the final tests the communication between aeroplanes and land station was as clear as that over an ordinary telephone line.

Aviation officers conducting the test said the aviators using the radio-telephone could hear the land station from a distance of eighty miles, while the airman could talk with the station from a distance of thirty miles.

\* \* \*

It is announced that Britain has accepted an invitation to be represented at the International Radio Conference next spring.

\* \* \*

The success of recent experiments in the wireless transmission of photographs was demonstrated by an exhibit at the seventieth annual exhibition of the Royal Photographic Society. The apparatus on which these radio-photographs were received can, it is understood, be constructed at a cost which will enable it to be retailed at about £10, a price which would bring it within reach of the amateur broadcasting enthusiast.

\* \* \*

Coincident with the opening of the German Wireless Exhibition in Berlin, the German postal authorities have withdrawn their regulations which hitherto prohibited the use of reaction in receiving sets, and henceforward German makers are allowed an entirely free hand as to the wavelength range embodied in their sets, instead of being restricted to the lower German band of wavelengths. In addition, home construction is now to be freely permitted. The effect of these alterations is very noticeable in the new instruments which are now exhibited, these being now built upon English lines.

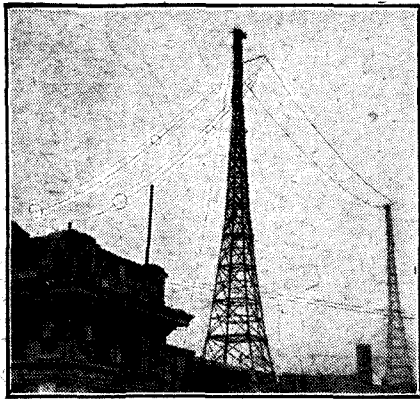

The London Station, whose aerial is seen in this photograph, departs from its published wavelength by as much as 7.3 metres.

# The B.B.C. and Their

By Major JAMES ROBINSON, D.Sc., Ph.D., F.R.S.

Some technical details, with actual figures, relating to the pr

WE have recently made some measurements of the actual frequencies of some of the B.B.C. stations, and we have already published the results in the first number of our new periodical, *Wireless*. These figures will be of interest to readers of *Wireless Weekly*, and they are repeated here.

of frequency and maintenance of a constant frequency. In fact, progress with frequency measurement has probably been greater than in any other branch of wireless. It has needed to be so, in order to allow of the use of the large number of services required. The demand for wireless communication has increased enormously in recent years, and is still increasing, and naturally there is a constant clamour for allocation of wavelengths for special services. It would be impossible to satisfy all demands without crowding the wavelengths allocated together. This crowding of wavelengths is bound to lead to absolute chaos unless each service restricts itself very closely to the wavelength given to it.

measuring and standardising frequencies.

It is possible to standardise wireless frequencies in the most absolute way. The standard of frequency is, of course, one vibration per second, and thus we are thrown back to the accurate measurement of time. Accurate measurement of "Time" has absorbed the attention of scientists for centuries, particularly in the realm of astronomy.

### The Multivibrator

It is possible to use the standard of time such as one second, and to obtain an instrument which gives an accurate frequency of one vibration per second, and compare that with any frequency we wish up to a frequency of millions per second. The instrument used for the purpose of this comparison is called the Multivibrator, and a considerable

Station.	Official.		Actual.		Discrepancy.	
	Metres.	Kc.	Metres.	Kc.	Metres.	Kc.
London .. .. .	365	821.4	357.7	838.19	7.3	16.78 -
Manchester .. .. .	378	793.2	372.1	805.75	5.9	12.55 -
Daventry .. .. .	1,600	187.4	1,607	186.57	7	0.83 +
Glasgow .. .. .	422	710.5	424.6	706.12	2.6	4.38 +
Bournemouth .. .. .	386	776.7	383.6	781.59	2.4	4.89 -
Swansea .. .. .	482	622.0	484.0	619.46	2	2.54 +
Newcastle .. .. .	493	743.97	491.5	746.74	1.5	2.77 -
Birmingham .. .. .	479	625.9	477.6	627.76	1.4	1.86 -
Cardiff .. .. .	353	849.35	351.8	852.24	1.2	2.89 -
Stoke-on-Trent .. .. .	306	979.8	303.5	981.40	0.5	1.60 +

It is at once obvious that there are considerable differences in some cases between the wavelengths announced by the B.B.C. and the actual wavelengths, amounting to 7.3 metres (16.78 kc.) in the case of London, and 5.9 metres (12.55 kc.) in the case of Manchester.

I do not propose to discuss the serious question of policy involved in publishing inaccurate wavelengths and varying them by accident or design. I only intend to give the facts, together with some technical data.

### Progress in Measurement

In these days we do not expect to have wavelengths inaccurate. There has been very great progress in recent years in the measurement

### Standard Expected

For this reason much technical work has been done in various countries to obtain the very best means for measuring frequencies, and in this country we have not been behind. Actually, some of the most important work has been done in this country. The progress has been so great that we now do not expect a fixed ground station to be more than a small fraction of 1 per cent. away from its published wavelength. In the case of mobile stations (i.e., ships and aircraft) a little more latitude should naturally be allowed.

### Methods Available

Let us consider briefly what means are at our disposal for

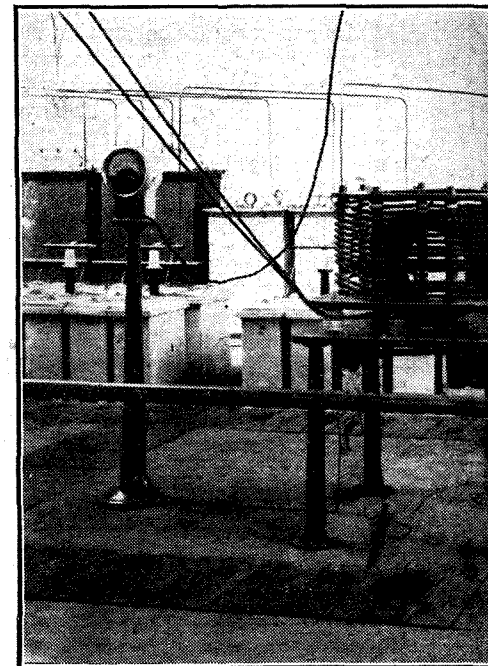

One of the difficulties encountered in measuring frequencies lies in the fact that the large inductances

# Published Wavelengths

J. P., Director of Research to Radio Press, Ltd.

em of the maintenance of constancy in broadcast transmission.

amount of work has been done on this by Dr. Dye, of the National Physical Laboratory. (A fuller description of this instrument will be given at a later date.)

Thus wireless frequencies can be measured and compared ultimately with standard clocks, and this is the very highest order of measurement that has ever been made.

## Use of N.P.L. Standards

We do not expect the B.B.C. to have such elaborate equipment as the Multivibrator at all their stations, and, in fact, it is possible to obtain very great accuracy without them. The N.P.L. standards are available, and the wavemeters used by the B.B.C. can be very accurately calibrated.

## The Quartz Resonator

Another subject in which great developments have occurred is in

the case of Quartz Resonators, some details of which were published in the September issue of *Modern Wireless*. It is possible to have these quartz crystals ground very accurately to a definite wavelength. They can be used to control the wavelength transmitted from any station.

At the National Physical Laboratory a very high standard of wireless frequency is maintained, and a series of transmissions takes place periodically on wavelengths which are controlled by the Multivibrator, and thus the actual wavelengths transmitted are absolutely standard. If means are not available for obtaining absolute frequency measurements by reference to one's own standard clock, the standard transmissions from the N.P.L. can be made use of so as to calibrate our wavemeters.

## Requirements in Heterodyne Wavemeters

A heterodyne wavemeter is preferable because it is capable of giving the highest accuracy, that is, a wavemeter which uses an oscillating valve. The inductances and condensers should be so constructed as to be absolutely constant, and the values of inductance and capacity should be very accurately known. As regards the condenser, there should be smooth and uniform movements, and the actual values of the condenser for various readings should also be very correctly known. In fact, the variable condenser should be one of the best that is possible to obtain. It is essential to guarantee that the conditions of this circuit shall be absolutely constant as referred to above. The anode current may have influence on the frequency, and thus it is advisable to work without any extra anode voltage if possible, and it is usually possible to use the heterodyne wavemeter on filament voltage alone. The same valve should be used throughout, for on changing a

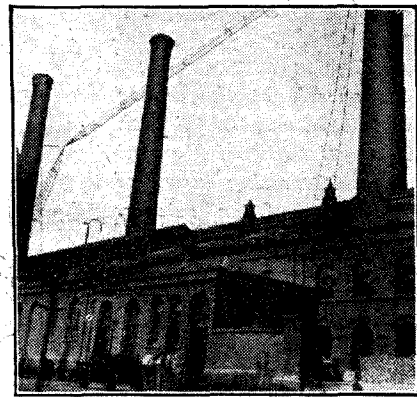

The Glasgow aerial indicates, by its proximity to other bodies, one of the reasons for the adoption of the master oscillator system.

valve quite different readings of frequency may be obtained. Every time a valve is changed it is necessary to recalibrate.

The constancy of the filament current is of the utmost importance, and a voltmeter should be used and the voltage measured from time to time in order to guarantee absolute constancy.

To obtain different ranges of wavelength it is advisable to have a number of coils of various inductances, and to plug these in as required, using the same condenser throughout.

## Calibration

To calibrate this wavemeter one standard wavelength from the N.P.L. should first of all be listened to and a reading of the wavemeter observed. Then another oscillating circuit should be used and adjusted to give a frequency identical with that of the transmission from the N.P.L. This can be done very accurately by adjusting it to give zero beat note with the wavemeter. Let us suppose that the wavelength is 2,400 metres (124.9 kc.). We now make use of harmonics of the local oscillator, *i.e.*, 1,200 metres (249.9 kc.), 800 metres (374.8 kc.), 600 metres (499.7 kc.), 480 metres (624.6 kc.), and so on, *i.e.*, we use the 2nd, 3rd, 4th, 5th, etc., harmonics, and observe the reading on the wavemeter in each case correctly. In this way a number of standard frequencies have been observed, and some points

(Continued on page 27.)

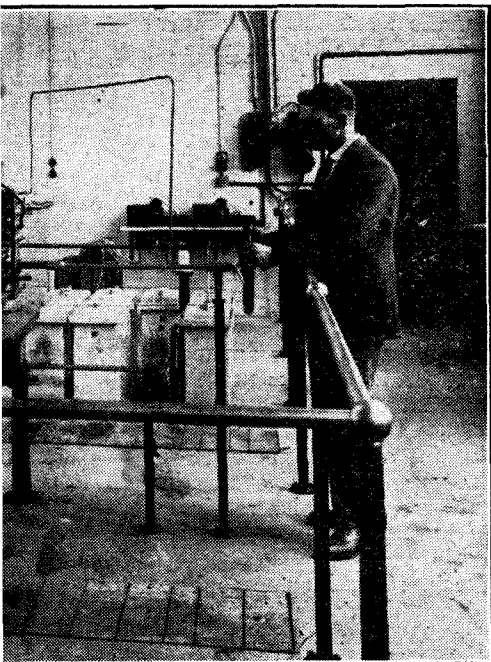

ing a constant frequency in transmission d may undergo variations in their constants.

# Thirty Years of Wireless—A Survey

By *Senatore G. MARCONI, G.C.V.O., LL.D., D.Sc.*

*In his speech at the dinner given to celebrate the thirtieth "birthday" Senatore Marconi made an interesting survey of the progress of the science.*

LOOKING back over a period of thirty years is not always a very easy task, but I must confess to a feeling of very great satisfaction, mingled perhaps with bewilderment, at the wonderful progress made by wireless or radio science since my first experiments and tests at my father's country house at Bologna in Italy.

I well remember, when I was a boy, reading of the classical and epoch-making experiments carried out by Professor Heinrich Hertz, which proved that Clerk Maxwell's hypothesis of the existence of ether waves was correct, thereby giving the world a new insight into the hidden mechanisms of nature.

Somehow or other, I soon came to realise the idea that these waves might be eminently adapted to a new system of communication through space which would possibly work over long distances.

## Early Experiments

My first plan was to produce these waves, and radiate them in a beam, by means of a metallic reflector, in the same way as had already been done within laboratories by Hertz, Lodge and Righi, and I hoped that by devising improved transmitters and receivers I might be enabled to communicate telegraphically over a distance of several miles.

I always believed that such a system, if workable, would be far superior to flashlights, or optical methods of signalling, by virtue of its independence of fog and mist.

After several attempts and failures I succeeded in the summer of 1895, which is just over thirty years ago, in obtaining telegraphic signals through space over a distance of  $1\frac{1}{2}$  miles.

These results encouraged me to further pursue my experiments, and to test all kinds of arrangements which, to my then very scant knowledge of the subject, seemed likely to permit the attainment of the object in view.

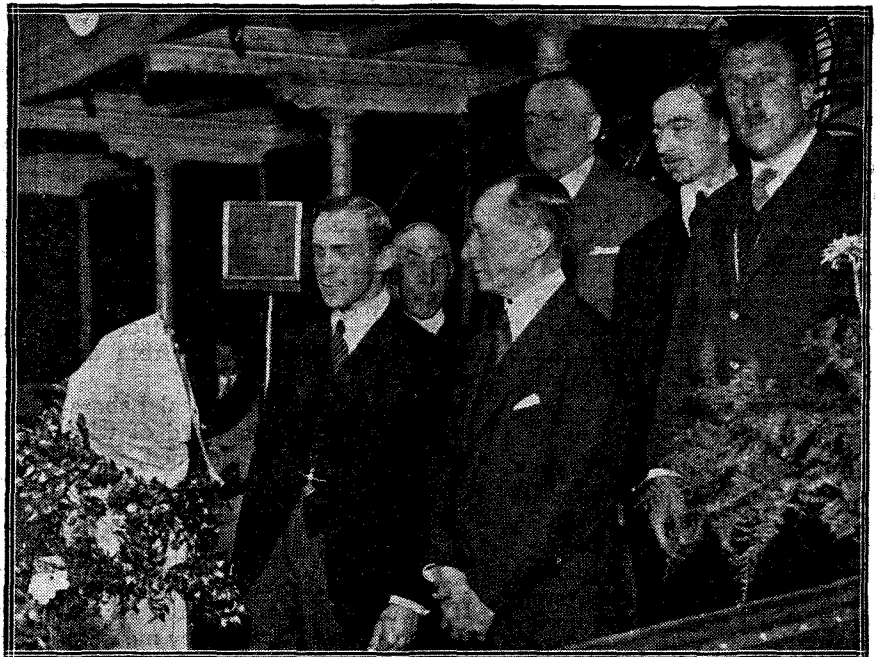

*Senatore Marconi (third from left) at the opening of the N.A.R.M.A.T. Exhibition by Viscount Wolmer (first on left).*

## Very Short Waves

My arrangement, employing reflectors and a Righi oscillator, utilised very short waves, that is to say, waves less than 1 metre in length, and therefore a good deal shorter than the shortest waves which have lately attracted the attention of radio experts and amateurs all over the world.

This system, however, at that time seemed only to work across clear space and would not operate if obstacles, such as houses or hills, happened to intervene between the two instruments.

## Introduction of Aerial Wire

I therefore tried other arrangements, but what gave the most promising results, and at the same time constituted a new departure, came about by the discarding of the reflectors, connecting one terminal of the spark-gap or oscillator to earth and joining the other terminal to a vertical wire connected to a plate or capacity suspended high up in the air, the distant receiver, which at that time consisted of a coherer arranged so as to be able to work a telegraphic instrument, being similarly connected to earth and to an elevated and insulated conductor,

This system, with the rudimentary means then at my disposal, gave reliable communication at about one mile, but the transmissions seemed to be quite unaffected by intervening bodies or obstacles.

## Development of Aerials

This arrangement, which was essentially a broadcasting system, soon developed into the elevated or vertical wire system, thus becoming the basis of all systems of long-distance radio communication.

I clearly remember thinking that this arrangement would be able to work really big distances and overcome the curvature of the earth and such apparent obstacles as mountains, etc., were it possible to efficiently utilise a large amount of transmitting energy in connection with much more sensitive receivers.

## Post Office Assistance

In March, 1896, I came to England and submitted my ideas to the late Sir William Preece, then Engineer-in-Chief to the Post Office.

Sir William Preece was greatly impressed with what I was doing, and I believe that he was one of the very few scientists who at that early date realised something of the



enormous possibilities of electric waves.

Although he had himself been working at the problem of wireless telegraphy on a method which utilised ordinary electromagnetic induction, he quickly realised that I was on a new track, and at once offered me his encouragement and assistance in the demonstrations and tests which he arranged for me to carry out for the Post Office.

I shall ever be grateful to the memory of Sir William Preece, and also to the authorities of the Post Office, who at such an early date realised the importance of the work in which I was then engaged.

#### Greater Range of Communication

The first public mention of my experiments was made by Sir William Preece at the meeting of the British Association for the Advancement of Sciences, held in Liverpool in September, 1896, and subsequently at other lectures he delivered in London. In June, 1897, at the Royal Institution, he was able to exhibit the apparatus in working order and describe results obtained in South Wales, where the distance of communication was extended to 9 miles.

It would be needless for me to dwell on the progress made since that date.

At times it may have appeared slow, whilst at others extremely rapid.

#### Research and Progress

But on the whole you will, perhaps, agree with me that the science and art of radio communication in the last 30 years has made gigantic strides, in many ways far exceeding the anticipations of the very few persons who, like myself, so many years ago believed in its future.

This wonderful progress has been made possible by the patient work of a host of investigators and experimenters the world over, amongst whom my own assistants should not be forgotten, nor should we either forget the important part played by the great radio companies and manufacturers in assisting and promoting research.

#### The Inventor of Wireless

In regard to myself, I must confess being at times amused at the discussions which occasionally take place as to who is the real inventor of wireless.

To my mind, wireless existed when the prehistoric man first understood or felt the meaning of a smile of encouragement from the

prehistoric girl, when human beings first succeeded in talking to each other or were able to understand or decipher signals or signs made to them from a distance.

What I think I did discover is that electric waves are capable of travelling and being received across very great distances.

#### Transatlantic Tests

The successful tests of wireless telegraphy which I carried out across the Atlantic Ocean in December, 1901, 24 years ago, proved for the first time that the possible range of these waves was enormously greater than almost anyone before that time had supposed, that the curvature of the earth was no real obstacle, and that radio communication would probably be possible across any distance on our earth.

#### Broadcasting

No remarks of mine are required to tell you what radio is doing at present, or into what an enormous industry it is growing.

Telephonic broadcasting, which became possible after the invention of the thermionic valve, is rapidly becoming a necessity in every civilised country as a potent means of disseminating instructions, information, and entertainment. In the short period of three years the number of licence-holders is now close on one and a-half million, representing a total audience of

communications, the all-important part it played in the Great War, and—above all—where nothing else so far can take its place, in diminishing the perils of navigation and in the saving of life at sea.

But the art of radio communication is now undergoing a complete process of evolution, the effects of which are still difficult to foresee.

#### New Developments

The extraordinary results obtained in recent years by means of short waves and the possibility of projecting these waves in beams covering only a limited angle or area, seem to indicate that the previously planned powerful and very expensive stations will no longer be necessary for long-distance communications, and that better and more reliable services can be established and maintained by means of much less costly stations working at higher speeds and utilising a far smaller amount of electrical energy.

Electric waves are proving to be far too valuable to be always broadcasted in all directions, especially when it is desired to communicate only with one particular place or area, and it is also for this reason that the new stations operated on what is called the "Beam System," which are now being erected for communicating between England, India, the Dominions, and foreign countries, are likely to provide what might almost be considered a new

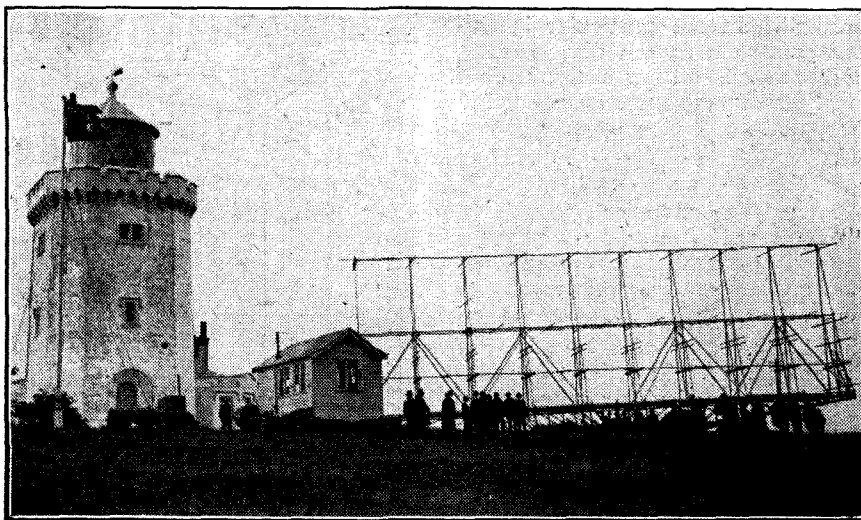

Senatore Marconi recently gave a successful demonstration of his new wireless "lighthouse," the aerial of which is seen here beside the South Foreland Lighthouse.

habitual and occasional listeners—in of 10,000,000 in this country alone.

We should not, however, forget what wireless has done for many years for commercial telegraphic

method of communication destined to fill a position of the greatest importance in further facilitating and cheapening communication throughout the world.

# Inventions and Developments

Under this heading Mr. J. H. Reyner, B.Sc. (Hons.), A.C.G.I., D.I.C., of the Radio Press Laboratories, will review from time to time the latest developments in the radio world.



PATENT has been taken out by C. and C. J. E. Dixon for a combined valve holder and rheostat. This apparatus is illustrated in Fig. 1, and it will be seen that one end of the resistance

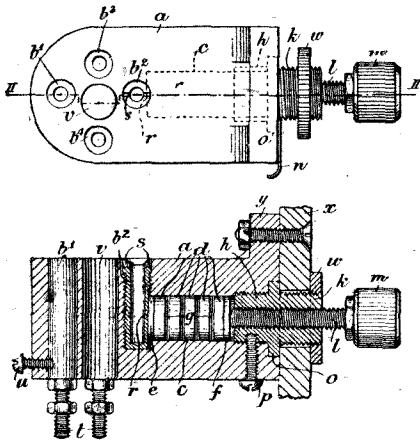

Fig. 1.—A combined valve holder and rheostat.

is connected direct to one of the valve legs, the other end of the resistance being brought out to a terminal. In the particular instrument shown a carbon disc rheostat is illustrated, although the use of any type of resistance is claimed in the patent.

Patent No. 238,459.

### A New Form of Low-loss Condenser

Patent No. 238,162, by Wilkins and Wright, Ltd., and J. H. Hewitt, describes a form of condenser in which a low-loss construction is aimed at by the elimination of one of the end plates. In order to accomplish this a particularly robust form of bearing has to be provided, and this is accomplished in the particular case by the use of a fine-threaded screw, in place of the more usual plain bearing. By this means a single bearing is enabled to give the necessary rigidity for the condenser. By the use of a suitable spring which tends to press the moving plates away from the bearing, a good electrical contact between the threaded spindle and the screwed bearing is obtained.

### Losses in Masts

There are one or two Canadian patents of interest to our readers. One of these relates to the losses which are obtained in the masts of an aerial system. Due to induced currents in the mast itself, a certain proportion of the energy supplied to the aerial is wasted. In order to obviate this, it is proposed that the mast should be insulated from earth, but that the aerial should be connected direct on to the mast. The mast, or masts, are then supplied with current substantially in phase with the current actually supplied to the aerial.

By this means the mast actually serves as an additional lead-up, and the currents therein are therefore useful instead of being wasteful. This principle may conceivably be of interest to the amateur transmitters in this country, although the insulation of the mast itself presents certain difficulties.

### Conduction Current in Metallic Coatings of Valve Bulbs

It has been found that in transmitting valves which have been exhausted by a process causing the deposition of a metallic film on the inside of the bulb, that eddy cur-

describes a method of reducing these currents by the connection of a metallic ring between the anode and the bulb.

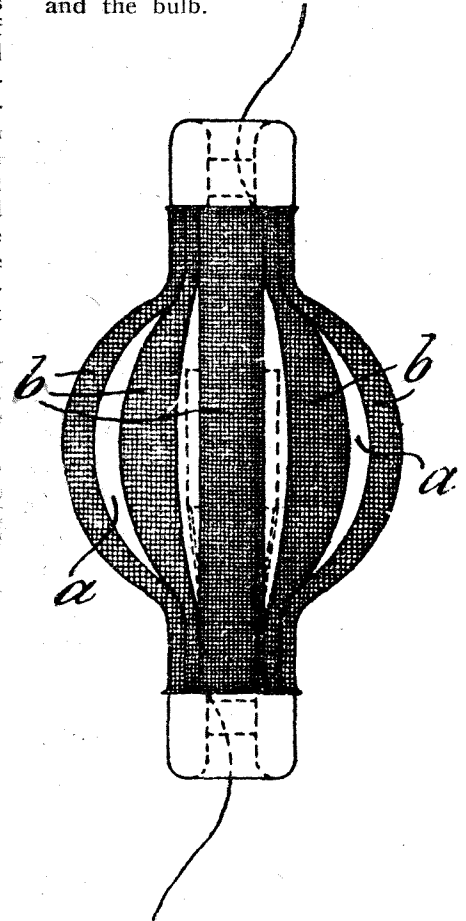

Fig. 3.—The screening arrangement described in Patent No. 238,265.

It is claimed that improved results are obtained by providing a conducting screen over practically the whole of either the outside or the inside of the glass bulb. This screen, being of a comparatively low resistance, has the effect of short-circuiting the metallic deposit of the bulb, which is of fairly high resistance.

The screen may, if necessary, be held at a fairly heavy negative potential to prevent it from attracting any electrons to itself or to the glass bulb. An illustration of the device, fitted as an external shield to an ordinary small type of transmitting valve, is shown in Fig. 3.

Patent No. 238,265.

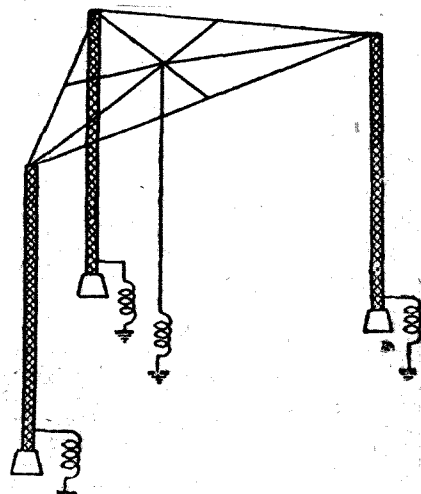

Fig. 2.—An arrangement for using the masts as part of the aerial, in order to reduce losses.

rents are set up in this film, which is conductive, so causing additional losses and other undesirable effects. Patent No. 201,585

## WHY DULL EMITTER VALVES ARE SILVERED—(Continued from page 11)

secured, and even if the grid is connected to the negative terminal of the filament, the contact potential causes the grid to remain slightly electro-positive to the filament, so that a grid current flows.

### Dull Emitter Filaments

In the case of dull emitter valves, however, having a filament of thoriated tungsten in the dull-emitting condition, or of alkaline earths, it is found that this contact potential between the grid and filament is in the opposite direction and therefore the grid is slightly negative with respect to the filament. This means, of course, that a certain positive potential must be applied to the grid before any grid current can commence to flow. In practice this necessary positive grid potential may be applied by connecting the grid (through the leak if necessary) to the positive side of the filament. This explains to some extent why the practice of connecting the grid leak to the positive of the filament has become now almost a standard practice.

This method of making the grid positive through the filament, however, fails if the voltage across the filament is less than  $2\frac{1}{2}$  volts. This is actually the case in some valves, notably the D.E.R. type of valve, on which the filament voltage is 1.8 only, and in this case, therefore, it would be necessary to connect the grid leak to some point even more positive than the positive leg of the filament. To obviate this difficulty, however, the grid of the valve is coated during manufacture with some highly electro-positive metal. The grid then fulfils the condition that it shall be electro-positive to the filament, and consequently satisfactory results can be obtained without the additional complication of an extra battery.

### Use of Magnesium

Now it so happens that magnesium is one of the most electro-positive metals there is, so that in the manufacture of the valve the magnesium which is used in the gettering process is placed on the inside of the anode of the valve, so that when it volatilises in the exhaustion process, it deposits itself all over the surface of the grid as well as on the bulb itself. The use of magnesium, therefore, serves

the double purpose, not only of cleaning up the vacuum inside the valve, but also it has this very subtle effect on the characteristic of the valve itself, and renders it more suitable for use as a grid rectifier.

J. H. R.

## THE LORENTZ COIL

A VERY simple way of winding a coil of particularly low capacity is provided by what is known as the "Lorentz" method. This coil resembles a simple basket turned edgewise so that it becomes roughly cylindrical, and the resulting low-capacity inductance is particularly suitable for use as a radio choke in short-wave sets.

Obtain first of all a base of hard wood or ebonite which may be either

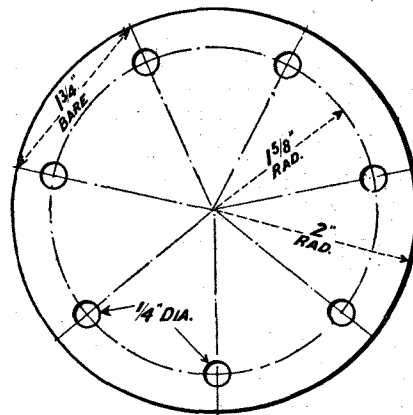
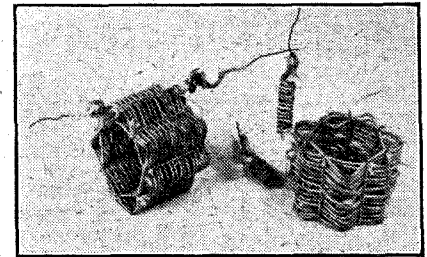

Fig. 1.—Dimensions of the circular base which supports the pillars.

square, or circular, as shown in Fig. 1. If circular it should be 4 in. in diameter, and if square the sides should have the same measurement. Fig. 1 shows how the circular former is laid out and drilled. I have used seven pillars in this design, but nine or eleven may be fitted if desired. To divide a 4 in. circle into seven parts set the points of a pair of dividers slightly under  $1\frac{3}{4}$  in. apart. Make a mark at some point on the circumference, and using this as your starting point travel round with your dividers. Then rule radial lines from the centre to each mark. Next describe a circle with a radius of  $1\frac{5}{8}$  in. At the points where the seven radii cut the circumference of this circle make punch marks, and at each drill a  $\frac{1}{4}$ -in. hole.

Now cut off seven suitable lengths of  $\frac{1}{4}$  in. round ebonite rod and insert them into the holes. They will, as a rule, fit so tightly into the holes that no further fixing is necessary; but if the drill is a trifle over size or the rods slightly less than their nominal



Coils of somewhat similar type to those described, the turns being tied together before slipping the coil off the former.

$\frac{1}{4}$  in. in diameter they may be fixed by drilling and tapping 6B.A. holes into them from the edge of the base and inserting  $\frac{1}{2}$  in. screws. If the former is of wood smaller plain holes may be drilled, fixing being done with fine  $\frac{3}{4}$ -in. nails, such as those used for fixing fretwork together.

We are now ready to wind the coil. Anchor the starting end in the following way. Drill a hole through one pillar quite close to its lower end and through this insert the end of the wire. Take a turn with the wire round the pillar and all will be secure. The wire is wound on basket-fashion over the first pillar, under the second, and so on, putting the turns on fairly tightly and continuing until as many as are required are in place.

When all the turns are in place take a knitting needle and space them out evenly and as far apart as possible at each pillar. This gives the maximum amount of air spacing

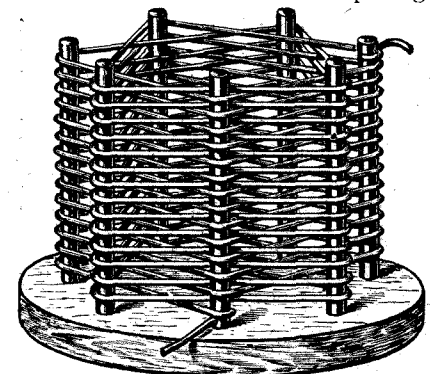
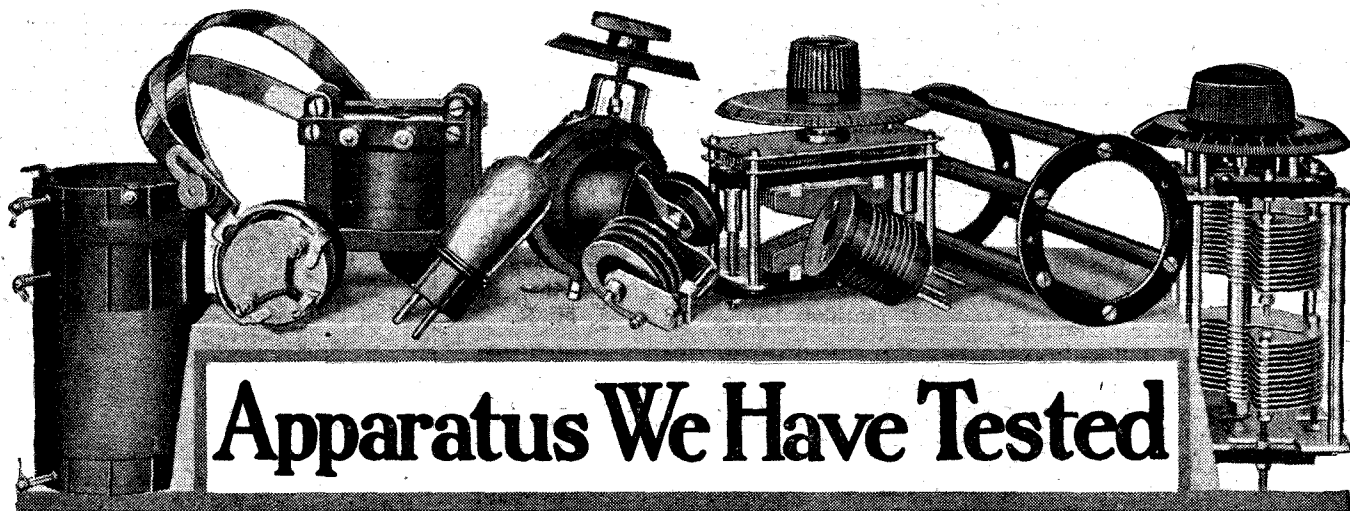

Fig. 2.—The completed coil can be left on the former.

and adds materially to the efficiency of the coil. By using pillars  $2\frac{1}{2}$  in. in length a very efficient 10- or 12-turn coil for short-wave work can be made.

R. W. H.



## Apparatus We Have Tested

Conducted by A. D. COWPER, M.Sc., Staff Editor.

### Armour-Clad Rheostat

Messrs. Electrical Equipment and Carbon Co., Ltd., have sent for test a sample of their "Armour-Clad" filament rheostat for D.E. valves. This has the usual flat spiral of resistance wire fitted closely inside a circular metallic casing of only 1½-in. diameter, an insulating lining being interposed. The contact-finger works round on the exposed rim. Neat and accessible terminals, and one-hole fixing are provided. Both contact-finger and knob, with its pointer, are secured in a most substantial and mechanical manner to their spindles; the whole device is made in a manner which suggests reliable service, and is highly finished. The resistance, on test, came out close to the nominal, 30 ohms; the instrument controlled satisfactorily the ordinary .06 type of D.E. valve, and would carry the current for an ordinary two-volt .3 amperes type, though warming up considerably in the latter instance.

### Armour-Clad Potentiometer

Messrs. Electrical Equipment and Carbon Co., Ltd., have also submitted a sample of their "Armour-Clad" potentiometer, uniform with the D.E. filament resistance reported on above; the barrel in this instrument is 2 in. in diameter, and the necessary three terminals are provided. The resistance proved to be no less than 600 ohms, so that the instrument can be used across the L.T. battery with every confidence that rapid exhaustion of the battery will not result.

### Re-wound Headphones

It is well known that telephones, in general, gradually lose their sensitiveness, particularly when used on a valve set without much care as to polarity of connections, or when allowed to fall about and receive rough usage. A break will often develop at an inaccessible point in the winding of perhaps one bobbin in an

otherwise perfectly serviceable pair of 'phones not of the inexpensive variety, and the permanent magnets naturally lose some of their power with age. Messrs. The Varley Magnet Company have submitted for our trial and criticism a pair of ordinary headphones which they have totally re-wound to 4,000 ohms resistance, re-magnetised and adjusted. Practical test of these exhibited a sensitiveness which compared favourably with that of a new pair of well-known make; the resistance was as stated, and the company appear to have made a thoroughly good job of the overhauling. Those who possess a favourite head-set which is beginning to show the effects of constant usage would be well advised, judging from this sample of their work, to send the 'phones along to Messrs. The Varley Magnet Co. for re-winding and re-magnetising.

### Lissen Wire Filament Resistance

Messrs. Lissen, Ltd., have sent for our test and criticism a sample of a new type of filament resistance of their manufacture, in which, unlike their well-known "Lissenstat" types, the resistance is in the form of a wire spiral. The bright-emitter pattern submitted had a flat spiral of resistance wire around the periphery of a circular moulding, and the usual spring contact-finger working on the edge of the spiral. A reliable central spring connection is made to this brush; small terminals and soldering-tags are provided, together with the customary one-hole fixing device. A knob and pointer and a neatly engraved metal scale for mounting outside the panel are also supplied. We were glad to note the substantial means for securing the knob and contact-finger; there is little probability of these working loose with hard wear. On trial, the resistance was around 10 ohms; the wire heated up on 1.7 amperes, but carried .7 amperes readily, and gave smooth, silent control of an R valve. Finish and workmanship were of a high order.

### Lissen Potentiometer

Uniform with the filament resistance in general appearance and build, the wire-wound potentiometer submitted by Messrs. Lissen, Ltd., proved to have the satisfactorily high resistance of 420 ohms on test, and gave a uniform control of potential when used as usual across the L.T. battery. The provision of an engraved external scale was found very convenient in practice; in particular the instrument gave close control over a detector valve when used for adjusting grid-potential through a fixed leak. It can be well recommended.

### Resin-cored Solder

Messrs. W. H. Agar have submitted a sample of their resin-cored solder for our practical trial. This is in the form of a narrow tube of the alloy in which a thread of resin is enclosed, which acts as a flux in soldering operations. The latter is evidently always available, and is applied just where needed; the convenience and cleanliness of this method of applying the flux became very noticeable in a practical test, particularly when soldering connections in a somewhat inaccessible position in a receiver. Resin is, in addition, a very safe flux for electrical work, and is often recommended for this purpose. The solder is rolled up in a neat spiral which provides a convenient handle whilst working. It can be recommended for home-constructional work.

## STEREOSCOPIC BROADCASTING

By H. J. ROUND, M.C.,  
is but ONE of the many fascinating articles in the second number of "Wireless"—the one-word weekly. Now on sale. Twopence everywhere.

## THE B.B.C. AND THEIR PUBLISHED WAVELENGTHS—(Continued from page 21.)

on the wavemeter definitely and accurately determined.

Now we take another standard wavelength from the National Physical Laboratory, say 2,800 metres (107.1 kc.), and again take the 1st, 2nd, 3rd, 4th, 5th harmonics, and so obtain still further points of calibration. In this way sufficient points can be obtained to enable us to calibrate the wavemeter over its whole range of wavelengths.

The wavemeter must be constantly checked to guarantee that it is correct.

### Causes of Variation

We understand the difficulties of maintaining the wavelength of a transmitting station constant.

For example, changes in the disposition of the parts of the transmitter produce changes in the interaction, which causes changes in the inductance in the set, and thus the wavelength alters. Again, when any considerable power is used in transmission, heat or moisture may cause changes in dimensions of coils and other parts, and thus small changes in inductance may occur. As regards the valves, changes in temperature of the filament, the heating of the grid and of the anode may produce changes in the actual dimensions of these electrodes, and thus changes in the relative disposition, which will alter the characteristics, tending to produce a change in frequency unless special precautions are taken.

### The Master Oscillator

Again, alteration of the anode voltage has an influence on the actual frequency unless very special precautions are taken. Nevertheless, there are means of making these influences small. The use of an independent drive, which is really a low-power oscillator controlling the main transmitter, and which can further be controlled by a quartz oscillator, is one of the best means of obtaining constancy of wavelength, and is to be recommended, so that it may be stated that there is no technical reason why an accuracy of one-half of 1 per cent. or better should not be arrived at and maintained.

### The Human Factor

In addition, there is the human element to be considered, and this,

of course, makes mistakes unavoidable. This necessitates constant watch by the B.B.C. on the actual wavelengths of their stations, and any discrepancies should be immediately dealt with. However, the disciplinary methods of the B.B.C. are outside of the scope of these remarks.

### Hope of Improvement

We expect very great accuracy of frequencies from the B.B.C., and they should aim at making their transmissions complete standards of frequency. We have considerable hopes that this will eventually be the case, for we have been observing the frequencies of the B.B.C. station during the Geneva tests. There is a very different story to tell here, and quite reasonable accuracy is being obtained. In some cases the wavelengths were absolutely accurate.

It will be our privilege, with the facilities of the laboratories at Elstree, to keep a friendly watch on the wavelengths used by the B.B.C., and the results of our tests will be published from time to time.

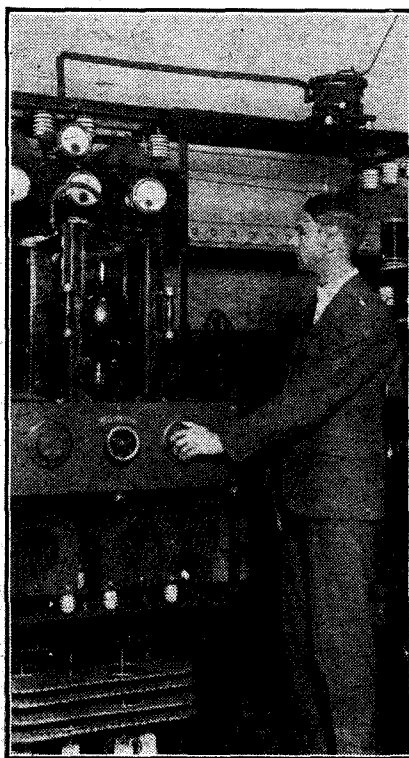

The "drive" or master oscillator panel at the Glasgow station.

## WHEN TO USE A LOW-LOSS COIL

(Continued from page 15.)

valve across only part of the inductance in its grid circuit, does not lead to a really marked decrease in signal strength. The relief of damping in the circuit produced by tapping the valve across a portion of the total voltage evidently compensates to a large extent for the diminution in the proportion of the voltage which is applied to the valve.

In this way it is quite possible to sharpen considerably the tuning of the circuit across which the detector valve is connected, and I show in Fig. 2 an example of this method. It will be seen that this circuit is in the main a simple three-valve arrangement employing tuned anode coupling between the high-frequency valve and the detector, but that the connection to high-tension positive from the tuned anode is taken through a tapping which is located at some little distance along the coil. Since, so far as high-frequency potentials are concerned, this tapping point is equivalent to a lead from the filament of the rectifying valve, it will be seen that this valve is connected across only a part of the whole tuned circuit, and therefore that the desired reduction in damping will take place.

### A Heavily Damped Circuit

In the grid circuit of the first valve, however, we have the familiar direct-coupled arrangement with parallel condenser, and here it is practically useless to employ a really low-loss inductance. Since the damping of this circuit is usually fairly heavy, no neutrodyne arrangement is shown, but on the contrary actual positive reaction upon the aerial circuit is indicated. With most aeriels and earths, of course, this is a perfectly practical arrangement.

I hope that this very brief discussion of some of the salient points which decide where to use the type of coil commonly known as a low-loss inductance, will show that a certain amount of consideration is involved in the proper employment of these coils, and that unless one devotes this consideration to the subject, one is apt to receive a disappointing impression of the capabilities of such improved tuning inductances.

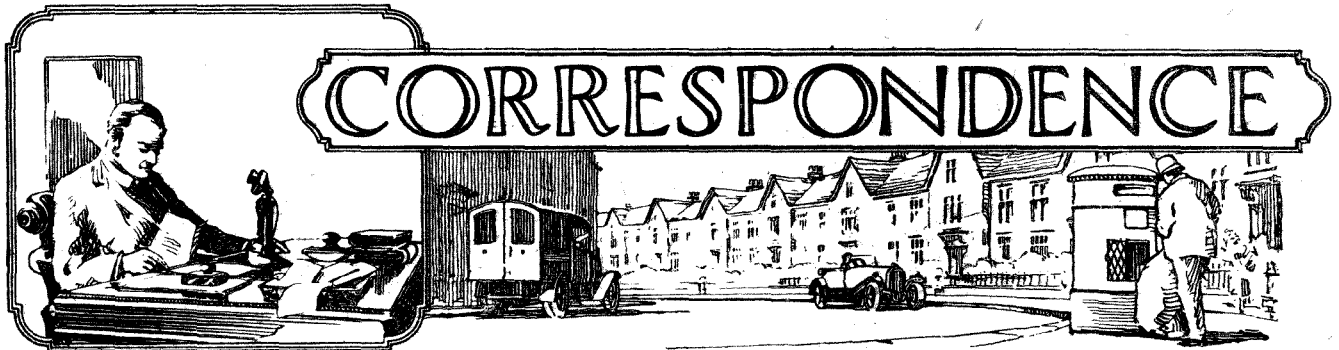

#### A "SUPER-FIVE" RECEIVER

SIR,—I would like to write and tell you that I have made up a "Super Five" as described in *Wireless Weekly* (Vol. 5, Nos. 13 and 14). The results are all you claim, are really wonderful, and no matter what the station or where it is, nothing is out of reach. Headphones are never used; it is the best set I have ever made or operated, and the one I intend keeping for myself.—Yours faithfully,

A REGULAR READER.

Woking.

#### A "SIMPLE SELECTIVE SET"

SIR,—I feel certain that a few results obtained with one of the circuits from your excellent journal will be of interest to other readers.

The set I wish to thank Mr. A. D. Cowper, M.Sc., for especially is the "Simple Selective Set," adapted for plug-in coils, in the issue of *Modern Wireless* for July, 1925, Vol. 4, No. 6.

I have built this receiver as a portable set, and am getting really excellent results, using a Mullard 6B6 L.F. valve with only 45 volts H.T. and a dry battery for L.T. supply and the components as described.

In the early part of August I took the set away on a camping holiday on the River Thames, and was able each evening to tune in 2LO and 5XX without the slightest difficulty. I was using 18ft. of rubber-covered flex as the aerial, and after experiment found the terminal A<sub>3</sub> the best to use. No earth connection whatever was necessary. Signal strength, from Staines right up to Pangbourne, over 40 miles from London, was really good on the telephones, in some cases audible up to several feet from the headpieces. These results were obtained with only 18ft. of flex thrown up into the most convenient tree, often quite a small willow. One night, near Henley, after the B.B.C. had closed down, two Continental stations, Brussels, SBR and one German station were quite clearly heard.

I think this is by far the best single-valve circuit I have tried. I intend to add two stages of L.F., and I shall be glad to give you some results when the set is completed.

On the original set it is quite easy to get several foreign stations and other B.B.C. stations with a good-outdoor aerial, and I hope with the L.F. amplifier to bring these up to loud-speaker strength.

I have had very good results from the several sets I have built during the last two years, and thank you for your valuable help.—Yours faithfully,

G. A. RIPPON.

Palmers Green, N.13.

#### AN "IMPROVED TWO-VALVE RECEIVER"

SIR,—In March last I constructed for a friend of mine the "Improved Two-Valve Receiver" (*Modern Wireless*, February, 1925, by Stanley G. Rattee, M.I.R.E.). The components and layout I modified a little, as my friend wanted the valves mounted under the panel, otherwise all the components were as specified. I might add I only entered into wireless in October last, and previous to constructing this set I had only constructed one for my own use.

The "Improved Two-Valve Receiver" which I had constructed I installed for my friend one evening about 6.30 p.m. (daylight), and the

Spanish, French and German stations at good strength. But that is not all. Last week he asked me to get him a loud-speaker. This speaker is now being worked on Daventry, this station being about 80 to 100 miles from Swindon, at quite good strength for a normal room. At times he is working the loud-speaker and two pairs of 'phones at the same time at a comfortable strength. I think this will take some beating, and is, of course, ample praise for your wonderful and well-described set.

I wish your papers every success in the future.—Yours faithfully,

F. A. GRIFFITHS.

Swindon.

#### THE "HARMONY FOUR"

SIR,—I have this week built up roughly the "Harmony Four" Receiver, published in this month's issue of *Modern Wireless*, by Percy W. Harris, M.I.R.E. Congratulations to Mr. Harris for such a fine circuit, quite

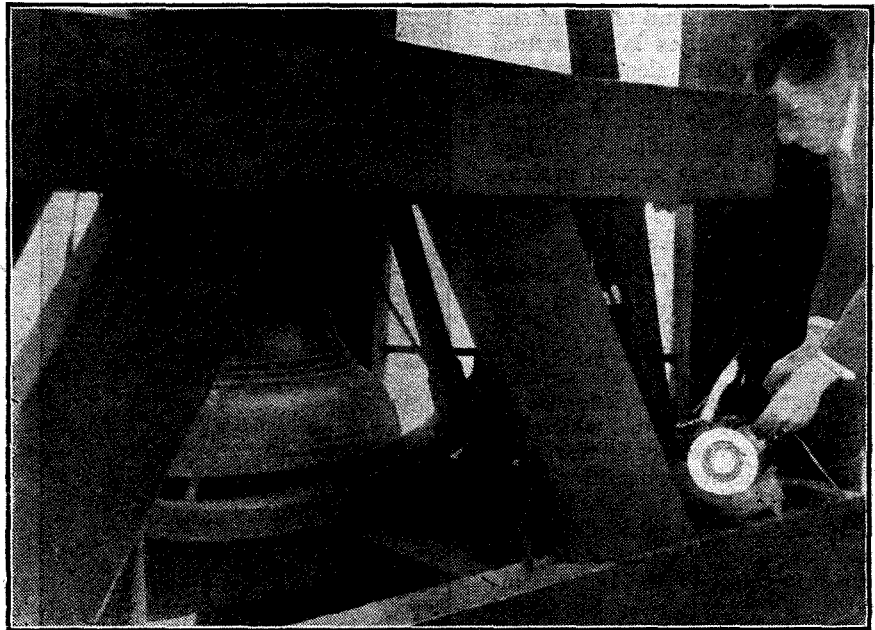

An engineer of the B.B.C. fixing the microphone in the belfry of St. Martin's in the Fields for broadcasting the sound of the bells.

first station to come in was Hamburg, on good 'phone strength. This, as you might guess, highly pleased him. He has since told me that he has received all the B.B.C. main stations on it at various times, and frequently

the best I have ever hooked up, and I have made a number now, including a seven-valve set. Tone is beautiful, no noisy background; I can tune in without bringing set to the point of oscillation.

London is very loud, Madrid very nice on the loud-speaker, and Birmingham almost as loud as London. Many other stations can be got quite well. I am using Cossor dull emitters and Cossor power valve. Have not yet had Daventry because I am waiting for some higher wave-band H.F. transformers.—Yours faithfully,

A WIRELESS ENTHUSIAST.

High Wycombe.

SIR,—I wish to let you know that I have just completed the "Harmony Four" (described by Mr. Percy W. Harris, M.I.R.E., in the September number of *Modern Wireless*), in which I have also incorporated a wave trap to assist in cutting out London, since I am so close to it.

After giving the receiver a trial I can honestly say it is as good as any I have ever handled, and I think this is about my 50th set from your papers.

As to results, I have received all B.B.C. stations at loud-speaker strength and several Continental. The volume from the nearer stations is terrific, and although I have a power valve I have no need to use it.

Considering there are three condensers, the set is simple to tune once one gets the hang of it, and even so one has no coils to fiddle about with. I find it far and away the best set yet, and a great feature is the purity with which signals are received. Using the finest components and new H.T. batteries, I have secured a silent background, which is a great asset to tuning in long-distance stations.—Yours faithfully,

B. GLADSTONE.

W.14.

#### A JUNIOR READER'S EXPERIENCES

SIR,—I thought you might be interested by the results I have obtained with the "Three-Valve All-Concert Receiver," described by Mr. Percy W. Harris, M.I.R.E., in "Twelve Tested Wireless Sets." On a rather poor aerial, 18 miles from Birmingham, I receive Daventry and Birmingham at full loud-speaker strength, also London, Nottingham, Manchester, Stoke-on-Trent, Bournemouth School of Posts and Radio Paris are excellent on the loud-speaker; Madrid, Hamburg, Brussels and Eiffel Tower are good 'phone strength. Belfast and Newcastle are rather difficult to tune in, but I get Vienna, Voxhaus and Rome very well. There are lots of other stations that I have not identified, but I have had one American station, although I do not know which it was. Tuning is critical, because I use two .0005  $\mu$ F variable condensers, but I have fitted a Colvern Vernier which improves the tuning. I use three Ediswan A.R.D.E. valves, and I have made my own coils.

I am only 14, but I have built about eight different sets, though I have not got much knowledge of wireless. Wishing you every success.—Yours faithfully,

JOHN F. ARGYLE.

Tamworth.

#### ENVELOPE No. 1

SIR,—I have completed building the ST100, and thought that you would be pleased to hear of the splendid results.

The instrument is wired according to the diagrams in Envelope No. 1 (by John Scott-Taggart, M.C., F.Inst.P., A.M.I.E.E.); all the component parts are as specified, with the exception of the 100,000 ohm resistance.

With a No. 50 fixed coil, a No. 75 movable coil, Mullard "Ora" valves and 69 volts H.T., I have succeeded in getting all the B.B.C. stations at 11 miles south of 2LO, but cannot get Cardiff, Bournemouth, or Manchester when London is working, owing to interference. Newcastle, Aberdeen, Glasgow and Birmingham are very powerful, and with another valve would work a loud-speaker well.

One peculiarity of the circuit is that London is too loud on the telephones and works a loud-speaker fairly well with no aerial at all, and with a wire flex about four feet long it is splendid.

Up to the present the only Continental station received is l'Ecole Superieure, comfortably loud on the telephones, but up to now no others have been tried for.—Yours faithfully,

EDWIN J. BALDWIN.

East Croydon.

#### THE "TWIN-VALVE" RECEIVER

SIR,—I think you may be interested to hear of the results obtained with the "Twin-Valve" Receiver (Radio Press Envelope No. 10, by John Scott-Taggart, M.C., F.Inst.P., A.M.I.E.E.). It is a remarkably sensitive set, and receives 5XX without aerial or earth. In this case the aerial was connected to earth outside the house, about 10 ft. away from the set. The reception was at moderate telephone strength, using a No. 200 coil in

the aerial circuit and a No. 150 for reaction.

On an indoor aerial consisting of 20 ft. of twin flex running along a passage, 5XX comes in at comfortable loud-speaker strength, and London, Radio-Paris and Newcastle quite loud on the telephones.

With an outdoor aerial 100 ft. long and about 26 ft. average height, the following stations are obtained with great regularity:—5XX, too loud on the loud-speaker to be comfortable, and easily heard all over the house (I usually de-tune to a moderate strength); London, Newcastle, Bournemouth, Radio-Paris and Petit-Parisien are received at good loud-speaker strength.

All other main stations and relays come in easily on the telephones, and, of course, dozens of Continental ones. I am also agreeably surprised to find that the set is almost as easy to handle on the shorter waves as on the long ones. I have had a great number of amateurs on wavelengths varying from 125 to 300 metres. I am delighted with the receiver, and feel that it is only right to let you know how satisfied I am. Wishing your excellent publications every success.—Yours faithfully,

HAROLD C. LEE.

Herne Bay.

#### AMATEUR CALL SIGN

SIR,—I should be pleased if you could announce in your papers that the call sign 5TG has been allotted to me. Power 10 watts, wavelengths 23, 45, 90 and 150-200 metres, C.W. and telephony.

Transmission on about 180 metres will commence shortly, and I should welcome reports.—Yours faithfully,

W. J. TARRING.

Forest Gate, E.7.

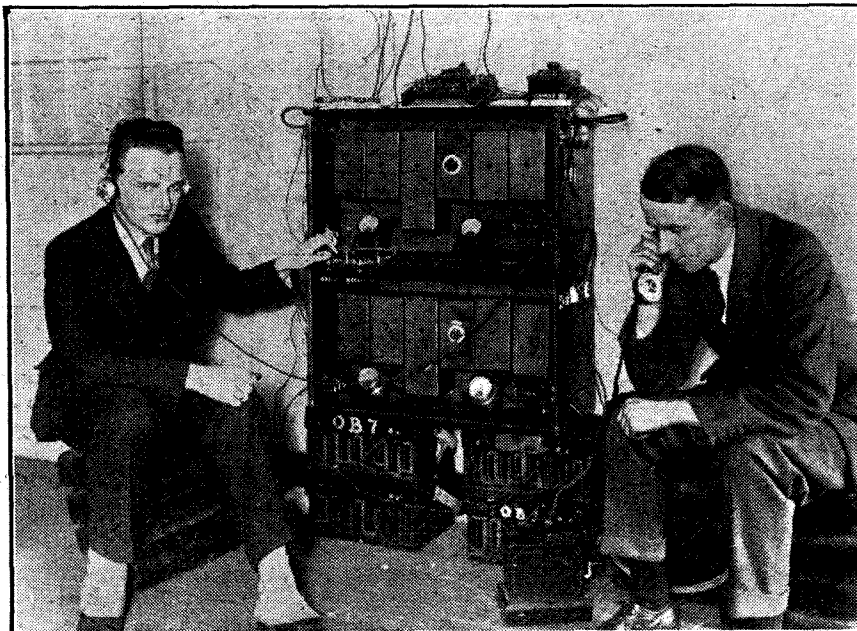

The control amplifiers installed in the Church of St. Martin's in the Fields, whence services are frequently broadcast.

# EFESCA Headphones

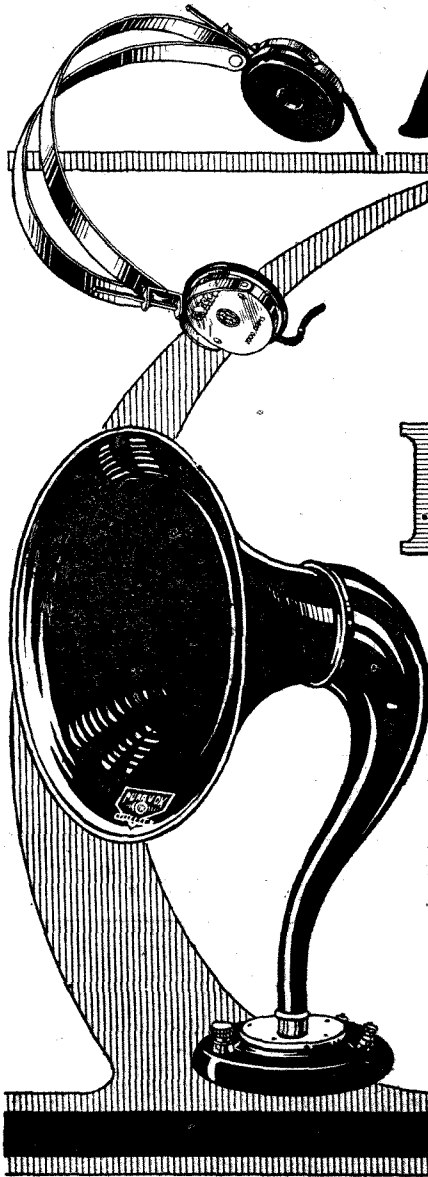

Efesca Headphones are exceptionally clear and evenly matched in tone. They provide both faithful reproduction and full volume of sound. The magnets are of cobalt steel, ground perfectly true, diaphragms of stalloy and headbands of polished duralumin. 4,000 ohms, with 6 feet of flexible cord, at the popular price of 18/-. Ditto 120 ohms, 18/-.

# PURAVOX Loud Speakers

For power and purity of reproduction the Efesca Puravox Loud Speaker is supreme. It is so constructed that the relation of the magnets to the diaphragm is capable of very fine adjustment, allowing the utmost volume of sound to be obtained. The horn is acoustically perfect, reproducing and magnifying the diaphragm vibrations with the utmost fidelity. Most handsomely finished with a crystalline surface.

Puravox Standard Model 80/- Puravox Junior 48/- Puravox Miniature 25/-

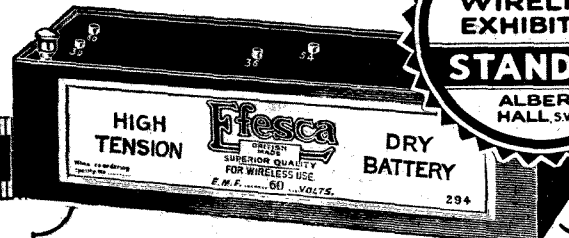

WHOLESALE ONLY.  
**FALK STADELMANN & CO., LTD.,**  
83-93, FARRINGDON RD., LONDON, E.C.1  
Also at Glasgow, Manchester & Birmingham.  
Send for Catalogue No. 559, illustrating and describing

# EFESCA COMPONENTS

## EFESCA High Tension Battery

The Efesca Giant High Tension Battery illustrated is constructed with specially large cells for Multi-valve or Power-valve sets of large current consumption. It incorporates a 1 mfd. condenser to stabilise the potential supplied and smooth out headphone "crackling."

72 volt battery, 24/-  
Also made in small-cell types.



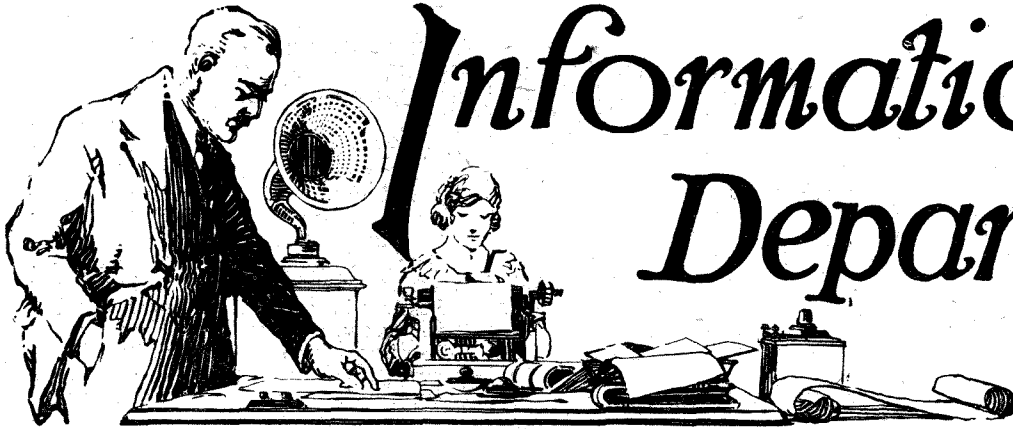

# Information Department.

H. F. (BASINGSTOKE) is puzzled by the somewhat strange behaviour of his All-Concert de Luxe receiver. When the filament of the H.F. valve is switched off signals are received, but as soon as this is switched on silence reigns. This phenomenon has only been observed during the last few days and previously the set worked satisfactorily.

A somewhat obscure fault of this nature is usually located in the high-frequency valve itself and not in the grid-leak, as our correspondent suspects. The explanation is very simple, although not obvious unless similar trouble has been experienced before. The cause of the signals coming through when the valve is not alight and ceasing when it is lit is that the

filament has sagged so as almost to touch the grid when cold and expands when hot so as to do so completely. This results in directly connecting the aerial to earth, so that there is no potential difference between grid and filament, and hence signals cease. When the valve is switched off on its rheostat the filament contracts so as not to touch the grid and signal energy is transferred to the detector valve through the internal capacity of the H.F. valve.

A cure may sometimes be effected by heating the filament to normal brilliancy, holding the valve in an appropriate position and giving it a number of smart taps with the hand. This may cause the filament to bend in a different direction and give a somewhat lengthened life. Even if this brutal

treatment completely breaks the filament, it is not material, since the valve would anyway be useless.

R.N.A. (WEST WICKHAM) wishes to know whether the Midget amplifier described in the September issue of "The Wireless Constructor" would be suitable for use in his locality. He has a crystal set on which he can hear London and Daventry but no other station, and he wishes to know whether the use of this amplifier would help him to bring in other B.B.C. stations.

The Midget amplifier referred to is a single-valve low-frequency amplifier. As a general rule low-frequency amplifiers are only useful for increasing the volume of signals which are



## WONDER WIRELESS BATTERY

Costs more than low capacity dry cells in the first place, but, since it can be continually re-charged, it is much less expensive in the long run. Can be re-charged at any C.A.V. Battery Service Station at a cost not exceeding 2/6. **YOUR H.T. SUPPLY for 12 MONTHS for 10/-**—less than the cost of one dry battery.

List No. 537—Fully charged (first charge free) **60/-**

Write for our complete catalogue.



**C.A.V. Vandervell & Co. Ltd.**  
ACTON VALE, LONDON, W.3

Oblige us by Kindly perusing the following Facts. Let us tell you something that is Well Worth Knowing Do not be sceptical—or doubt us—when we say,

“Valves that are damaged—old—or burned Are capable of being Restored as good as New.” Learn how you can Put money in your Pocket. Verify the truth of this assertion, by giving us a trial: Entrust to us “ONE VALVE” and in Seven Days we will Send it back (Post Free) in Perfect Order.

Made to Function with all Original Characteristics, Actual Valve sent us returned with Efficiency Maintained. D.E. .06 9/6 — D.E. 2 V. .3 7/6 — B.E. 4/6. Experts carry out the work and Results Guaranteed.

Note—We save you about Half Original Cost, Every order Carefully Executed—Examined and Promptly despatched. WRITE — PHONE (Clissold 82) — or CALL

**NORTH LONDON VALVE CO., LIMITED,**  
22½, Cazenove Road, Stoke Newington, N.16

*Special Terms to Wireless Agents.*

## Put your coils out of sight



**To carry 2 coils:—**

Here is an entirely new type of Coil Holder with all American-type Sets with Valves at back of panel. Special indicator shows exact position of moving coil. Friction drive permits vernier movement ... .. 12/6

**Skeleton Coil Holder.**

A smart new coil holder with plated fittings. Long detachable handle for easy and accurate control ... 6/6  
To carry 3 coils ... 8/6

**For 3 coils:—**

Exactly as illustrated above. Note two indicators to show position of moving coils 16/6

**Dull-e-dapt Resistance.**

Specially designed to permit 2-volt dull emitters being used from 4- or 6-volt accumulators, without alteration to Set ... 3/6 each

*State which valves you are using and the voltage of your accumulator.*



**Experimenters:—**

These items are from our 48 page Catalogue. Send 3d. for a copy at once and see how much you can save by buying from us. Prompt delivery and all goods guaranteed. If you are building a Super Heterodyne get particulars of the Keystone to-day. The simplest and most economical on the market in sets of parts for the home Constructor.

**PETO-SCOTT Co. Ltd.**

Registered Offices, Mail Order and Showroom,  
77, City Road, London, E.C.1

Branches: LONDON—62, High Holborn, W.C.1.  
WALTHAMSTOW—230, Wood Street.  
PLYMOUTH—4, Bank of England Pl.  
LIVERPOOL—4, Manchester Street.  
P.S. 3580.

already audible. Although in certain cases the addition of a low-frequency amplifier to a crystal set will result in stations being heard which are inaudible on the crystal set alone, it is usually preferable to employ high-frequency amplification if it is desired to extend the range of a crystal set. By amplifying the incoming signals before they are applied to the detector the latter is enabled to operate more efficiently, and a correspondingly greater signal strength is obtained. This results in signals being audible from stations which are not heard on the crystal set alone. We would recommend our correspondent, therefore, to make up a high-frequency amplifier for his set rather than to use the amplifier to which he refers.

**L. M. O. (GLOUCESTER)** wishes to know whether "neutrodyne" a high-frequency amplifier is worth the extra trouble. He wishes to know whether a neutrodyne high-frequency stage will give better results than an ordinary tuned anode.

This matter is somewhat outside the scope of the Information Department, which exists more for the purpose of replying to specific queries. We may say, however, that a "neutrodyne" arrangement or some suitable form of neutralising the effect of the inter-electrode capacity of a valve is undoubtedly of great service in a high-frequency amplifier. The difficulty with ordinary high-frequency amplification is that when the amplification

per stage reaches a certain value continuous oscillation or howling is produced. The more efficient the particular stage of amplification is the more readily is this howling produced. The use of a neutralising arrangement enables the amplification to be made reasonably efficient whilst at the same time the tendency to self-oscillation is counteracted. This means, of course, that the actual amplification of the particular stage can be greater with a neutralising arrangement than without, so that there is a distinct advantage in the use of a neutralising scheme. The answer to the second part of our correspondent's query is one which depends to a large extent upon the actual conditions existing in the particular set, but as a general rule, if both the tuned anode and the neutrodyne arrangements are tolerably efficient and properly constructed, there would be a superiority exhibited by the neutrodyne arrangement. The best course of action, of course, would be to combine the two and to employ a neutrodyne tuned anode circuit. Such a circuit, if properly constructed, is capable of giving very good results.

**J. C. W. (DARTFORD)** has constructed a "Family" 4-valve receiver from Radio Press Envelope No. 2, with which he is obtaining very unsatisfactory results. He reports that with the detector only no signals whatever can be received. The addition of the high frequency valve allows him to obtain the London station at very poor

strength, the set oscillates in a very uncontrollable manner, is extremely prone to howling, and no control of reaction is given by adjustment of the potentiometer.

Experience has shown us that with a set of this type difficulties such as our correspondent is experiencing may generally be traced to a defective potentiometer, which should be changed. Whenever a four-valve Family receiver behaves in a peculiar manner, oscillating freely, and howling badly when the low-frequency stages are switched into circuit, the potentiometer should be suspected. It is not necessary to change this component to decide definitely whether it is the offender, since it can easily be cut out of circuit. Reference to blue print No. 2 will show the two ends of the potentiometer winding connected respectively to F+ and the long lead which joins one side of the filament resistances to L.T. negative. These two leads should be disconnected from the potentiometer as should the one to the slider from the earth terminal. Now join the latter lead to the one from F+, leaving that from L.T. negative free and arranged so as not to touch any of the other wiring. Connect the set up in the normal manner and tune in to any available transmission. If the receiver is now found to be stable and the valves to give the expected step-up in signal strength, the potentiometer is undoubtedly responsible for the previous poor results, and should be changed for a new instrument.

**IF YOU WANT—**

Sharp Selective Tuning,  
Clear Speech, and  
Maximum Strength—refit with

**"TANGENT" TUNING COILS**

You won't have to apologise for your set—your friends will be charmed with the pleasing performance.

See our Stand  
No. 7  
at the N.A.R.M.  
Exhibition, Royal  
Albert Hall.

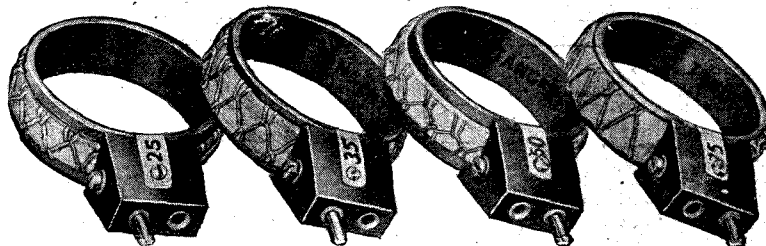

Above are obtainable from all good dealers—  
or direct from—

**GENT & Co.,**  
Ltd. Est. 1872.  
"Faraday Works," LEICESTER.

London:—25, Victoria Street, S.W.1. Newcastle/Tyne:—"Tangent House," Blackett Street.

PRICES:—  
4/3 to 10/-  
according to wavelength  
Wavelengths from  
250 to 9,500.  
Catalogue 8W on  
request.



**R. S. P. (KINGSDOWN) finds an ordinary buried earth unsatisfactory, since he is surrounded by shingle, and asks our advice on how to erect a counterpoise.**

An effective counterpoise arrangement, and one that is generally adopted by large commercial transmitting stations, is one which extends past the free end of the aerial to a distance, roughly equivalent to one-half of the horizontal length of the aerial, and consists of a number of parallel wires extending on either side to a distance usually equal to the height of the aerial. The whole of this system is suspended on a series of masts 20 or 30 feet high, and is thoroughly well insulated from earth, the parallel wires being joined together and led into the station in a similar manner to the aerial.

Our correspondent will, however, for reception purposes, not find such an elaborate system necessary. Two wires well insulated, preferably 6 feet or so up, stretched directly underneath the aerial, well insulated and led in through the same type of lead-in tube as employed for the aerial should prove satisfactory. Ordinary 7/22 hard drawn copper wire will prove suitable, and equal care with its insulation should be taken as with the aerial. With such an arrangement tuning will probably be found considerably sharpened and reaction demands lessened so that a smaller reaction coil

than is used with a buried earth will generally give satisfactory control of oscillation.

**E. M. (TONBRIDGE) wishes to use his direct current supply mains for charging accumulators in conjunction with a bank of lamps and asks our advice on how to determine the polarity of the mains and which side is connected to earth.**

A very simple and effective test which will easily determine the polarity of direct current mains may be made as follows:—Fill an ordinary jam-jar with water and add a small quantity of common table salt. Two insulated leads with ends bared for an inch or two at one end, should now be connected from the "point" from which it is desired to take the supply for charging, and the two bared ends of the leads should be inserted into the water in the jar and held separated at a distance of two or three inches. Electrolysis will take place and bubbles will arise round both wires. Around one lead, however, considerably more bubbles will arise than around the other. The particular lead from which most bubbles rise is the negative. Care should be taken not to touch the bared portion of the leads, when the current is switched on, and they should not be allowed to come into contact or a short-circuit will take place which may blow the house fuses.

Which side of the mains is earthed can easily be found if an ordinary lamp, such as is used on the supply, is connected in turn between each lead and earth. The lead which does not permit the lamp to light, when connected in the above manner, is the one which is earthed.

**J. C. (BRISTOL) asks what is the meaning of the expression "tune stand-by switch"?**

This expression dates from the use of certain commercial receivers, upon which there was a change-over switch, whose two positions were marked respectively "tune" and "stand-by." When in the "tune" position, a loose-coupled tuning system was employed, giving selectivity and freedom from interference, while upon the "stand-by" side, a single-circuit tuner was used whose tuning was less sharp, and was consequently employed by the operator when standing by for signals, since it made the picking up of the call more certain. A similar switch is useful in any receiver which possesses a loose-coupled circuit, since it enables one to switch over to the simpler direct-coupled arrangement to pick up distant stations. When the station has been accurately tuned in upon the primary circuit one can change over to the loose-coupled arrangement and tune in upon the secondary circuit.

## Why is

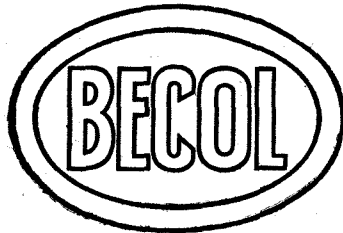

### THE HALL MARK OF "QUALITY" EBONITE?

*Because* it is made from finest rubber and sulphur

IT HAS  
PROVED ITSELF

ITS POLISH  
SPEAKS FOR ITSELF

All branded panels guaranteed free from surface leakage.

Write for full particulars and List B.

The **BRITISH EBONITE Co., Ltd.**, HANWELL, LONDON, W.7

See  
**STAND 15**

N.A.R.M.A.T. Wireless Exhibition,  
ROYAL ALBERT HALL,  
SEPTEMBER 12-23.

*Rods, Tubes and Mouldings*

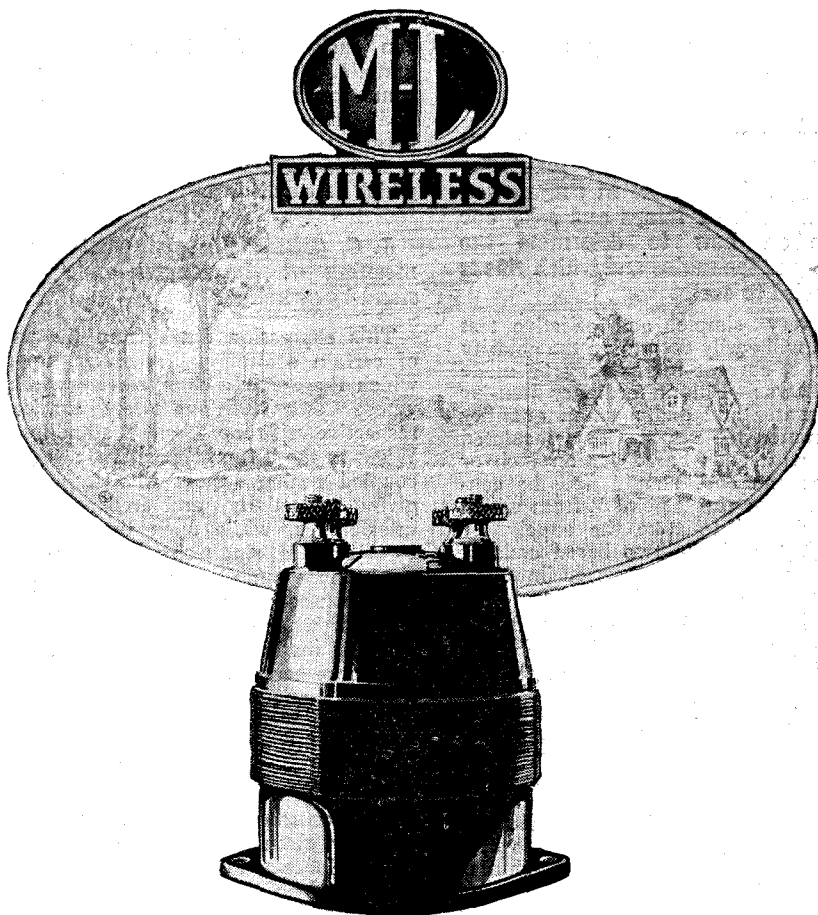

## What Others Think.

**I**T would be easy for us to write an advertisement telling you all about the sterling merits of the M.L. Transformer.

We think it is the best transformer that has ever been placed on the British market. Perhaps that is only natural since we are so interested in it. But here is what someone thinks who has no interest in the M.L. transformer, other than that of a satisfied user.

His testimonial is entirely unsolicited. Here is what he says:—

*"As you are aware, I have tried out practically every make of L.F. Transformer available to the amateur, and, in my considered opinion your latest production is superior to anything I have previously tested."*

The 1:6 ratio is used for amplification after a crystal rectifier. The 1:4 ratio is used for single stage L-F Amplification. The 1:2.6 and 1:4 ratios are used respectively in the first and second stages of two-stage amplification.

**25/-**

**S. SMITH & SONS (M.A) LTD.**  
179-185 Great Portland Street, London, W.1

Telephone: Langham 2323 Telegrams: "Speedomet. Telew. London"  
Also at Birmingham, Manchester, Glasgow and Belfast.

# S. SMITH & SONS (M.A) LTD

E.P.S.4

AN ADVERTISEMENT IN "WIRELESS WEEKLY" IS A GUARANTEE OF SATISFACTION TO BUYERS.

## Wireless Weekly Small Advertisements.

**ENGRAVING** ebonite panels by machine. Low price for quantities. Single panels engraved. Express Delivery.—Endacott's, Ltd., 58g, Hatton Garden, E.C. Phone: Holborn 1809.

**BARGAIN**.—Latest model "B" Gambrell 4-Valve Neutrodyne Receiver, separate double circuit Tuner, complete set of coils and valves; guaranteed perfect; any evening. £27 10s. cost double.—Edwards, 54, Princes Park Avenue, Golders Green, N.W.

**PATENTS**, Trade Marks, Inventions, Advice, Handbook and Consultations free. B. T. King, Regd., Patent Agent, 146a, Queen Victoria St., London, E.C.4.

**TELEPHONE RECEIVERS** and Loud Speakers Rewound, 2,000 ohms, 3/6.—A. Roberts & Co., 42, Bedford Hill, Balham, S.W.12.

**2 VALVE Amplifiers**, 35/-, use one or two valves; also 1 Valve Amplifier, 20/-, both perfect as new. Valves, 4/6 each. Smart Headphones, 7/6 pair. New 4-volt Accumulator, celluloid case, 13/- New Dura 60-volt H.T. Battery, guaranteed, 6/- 2-Valve All-Station Set, works speaker, £4. Approval willingly.—W. TAYLOR, 57, Studley Road, Stockwell, London.

**HEADPHONE REPAIRS**.—Re-wound, re-magnetised, readjusted. Lowest prices quoted on receipt of telephones. Delivery three days. Est. 26 years.—Farley Magnet Co., London, S.E.18.

**FOR SALE**.—Amateur has following new materials for Sale:—Three sets Hart H.T. Batteries, 24 volt each, in makers' cases, 50/-, no acid; Square box pattern Laboratory Ammeter 1 to 10 amperes, 20/-; 1granic 3-coil holder, 10/-; 2 Silvertown Intervalve Transformers, 30/-; 2 ditto ditto, push pull, 30/-; 1 pair Silvertown Phones, 4,000 ohms, 20/-; 1 pair Sullivan, 10/-; 1 Sterling geared Condenser, .0005, 12/-; Set of six Lissen Coils, 30-150, 20/-; 1granic Multi-coil with switch, 200, 350, 600, 800, 20/-; 1 ditto Unitune 300-600, 6/- Or the whole for £10.—Hoare, Brownlow, Hindhead.

## Electradix Radios

THE increasing scope of wireless apparatus has necessitated a wide increase in our already large and comprehensive stock in London. Our new July edition of our famous **Catalogue of Radio Bargains** now contains 500 illustrations of radio sets, components, and electrical instruments of great interest. Many of these are very obtainable elsewhere and our prices are the very lowest. The experimenter on short waves, the expert transmitter or the crystal novice will all find it advantageous to have a copy of

**"THE CATALOGUE THAT SAVES YOU POUNDS."**

Its scope ranges from a 5s. pair of British Headphone, or a 12.6d. Milliammeter to a 30,000 volt Generator, and covers all requirements. If you cannot call and inspect goods in our showrooms between 9 a.m. and 6 p.m., it will pay you to send 4d. for our catalogue at once. Goods promptly despatched all over the world. Colonial Avenue is the first on left down the Minorities from Fenchurch Street or Aldgate Underground Station.

Call or Write for new and enlarged catalogue:  
**LESLIE DIXON & CO., LTD.**  
9, Colonial Ave., Minorities, E.1.

\*Buses pass the door. Telephone: Avenue 4166.



**RILEY'S BILLIARD TABLES**  
for the home.

Send for  
**FREE**  
Price List

Riley's "Home" Billiard Tables—To fit conveniently on any dining table. Prices from £7 or in monthly instalments. Riley's "Combine" Billiard and Dining Tables to suit any room. Prices from £22 10s. or in monthly payments. 7 days' Free Trial and Carriage Paid.—

**E. J. RILEY, LTD., BEAUMONT WORKS, ACCRINGTON.**

## ZIGZAG

ELECTRODES OR EARTH PLATES

**END YOUR EARTHLY TROUBLES.**

Electrical & General Sundries Ltd.  
4 Victoria Street, S.W.1.

# WIRELESS

2<sup>D</sup>

THE ONE-WORD WEEKLY

Technical Director :  
JOHN SCOTT-TAGGART, F.Inst.P.,  
A.M.I.E.E.

Editor :  
PERCY W. HARRIS,  
M.I.R.E.

Research Editor :  
MAJOR JAMES ROBINSON, D.Sc.,  
Ph.D., F.Inst. P.

**“An Astounding Success.”**  
**No. 1 “SOLD OUT”**  
**450,000 COPIES WERE PRINTED!**  
*Make certain you get No. 2*  
**NOW ON SALE.**

Contents include the following interesting articles :

ANIMALS AS BROADCAST ARTISTES,  
by Captain A. D. G. WEST, M.A., B.Sc.

SECRETS OF AMERICAN SELEC-  
TIVITY, by PERCY W. HARRIS, M.I.R.E.

THE INNER HISTORY of the GRIN-  
DELL-MATTHEWS DEATH RAY,  
by Major JAMES ROBINSON, D.Sc.

CIRCUITS YOU WILL USE THIS  
WINTER. No. 2,  
by JOHN SCOTT-TAGGART, F.Inst.P.,  
A.M.I.E.E.

STEREOSCOPIC BROADCAST-  
ING, by Captain H. J. ROUND, M.C.

FROM MY ARMCHAIR,  
by Earl RUSSELL.

THE NEW S.T.100 RECEIVER,  
by JOHN SCOTT-TAGGART, F.Inst.P.,  
A.M.I.E.E.

THE CENTODYNE,  
by PERCY W. HARRIS, M.I.R.E.

A LOW LOSS SET FOR DAVENTRY,  
by A. S. CLARK.

IS LOOSE COUPLING WORTH WHILE?  
by J. H. REYNER, B.Sc. (Hons.).

HOW CRYSTALS ARE RUINED,  
by JOHN W. BARBER.

TUNING A NEW SET,  
by A. JOHNSON-RANDALL.  
LOOK AFTER YOUR  
PHONES,  
by P. H. WOOD, B.Sc.  
(Hons.).

EVERY  
TUESDAY  
**2<sup>D</sup>**  
WEEKLY

ON SALE EVERYWHERE.

**BUY YOUR COPY TO-DAY!**



EDITED BY PERCY W. HARRIS, M.I.R.E.

# WHY THE R.I. CURVE IS RIGHT

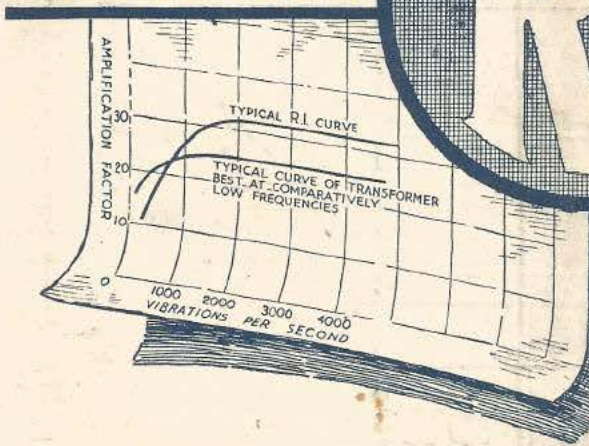

## For Symphony or Solo

The first essential of the skilled orchestral conductor is the power to maintain correct balance among all his instruments. The note frequencies of these instruments may vary anywhere between 30-30,000 cycles per sec. The predominance of any one instrument or frequency would upset the whole theme of his music.

The Radio Transformer is faced with exactly the same situation. The wide range of note frequencies that are presented through the medium of broadcasting must be amplified without emphasis on any particular instrument or frequency, or else the resulting reproduction will be imperfect in value and distorted.

Even in the case of a solo the amplification must preserve the minute overtones that give character to the rendering.

This problem of perfect amplification calls for years of research and difficult experiment.

Any transformer will give you electrical amplification. It takes the R.I. Transformer with 25 years of experience behind it to give TRUE musical amplification.



25/-

Write for R.I. Catalogue,  
free on application.

